

FICHA TÉCNICA

Electroímã 280Kg com temporizador, sinal de estado, LED e câmara de vídeo integrada



YM-280CAM

- Modelo: YM-280CAM
- Força de tracção: 280Kg
- Voltagem de trabalho: 12 VDC/480mA ou 24 VDC/240mA
- Segurança de pessoas: Abre com falta de tensão
- Com temporizador regulável no fecho
- Com LED indicador de estado
- Caixa em alumínio anodizado
- Magnéticos em aço zincado
- Placa em aço zincado
- Saída de Vídeo: PAL/NTSC
- Tamanho: 280x48x26,5 mm
- Peso: 2,5Kg

Dimensões

Câmara de vídeo

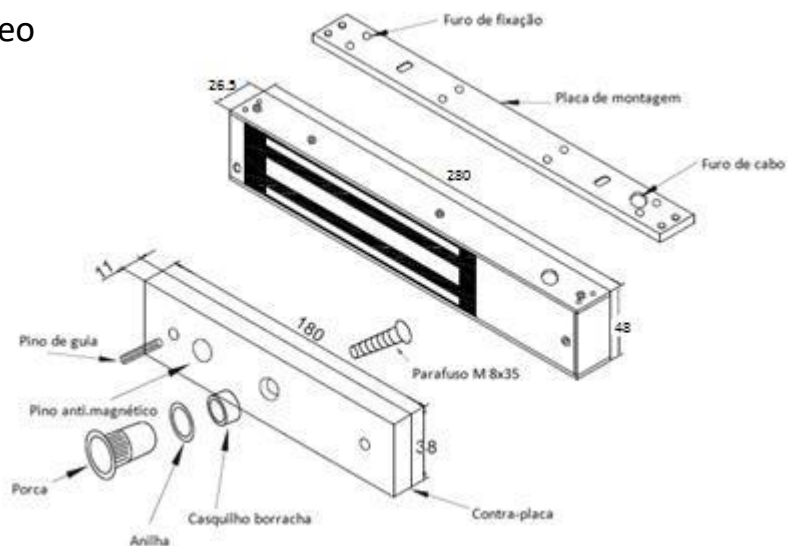
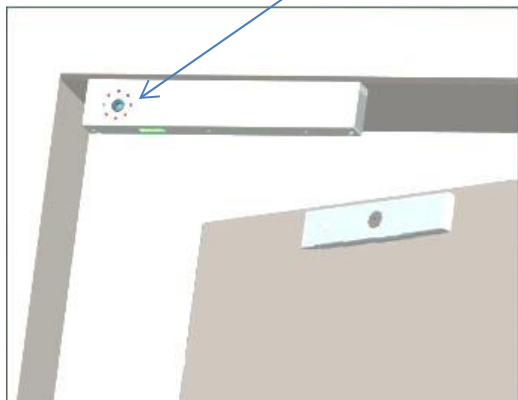



Triplow

YM-280CAM

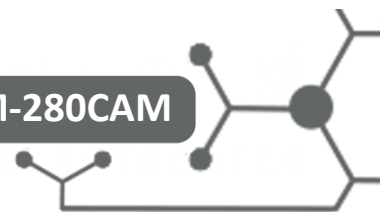

Instalação

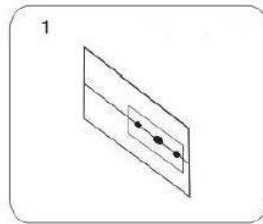
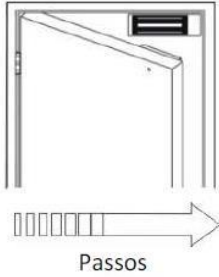

1 Escantilhão

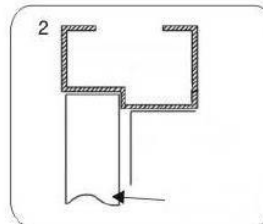

2 Feche a porta, encoste o escantilhão no aro

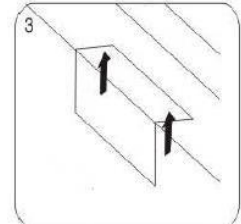

3 Marque os furos no Aro e na porta

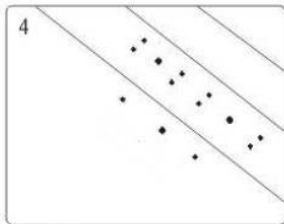

4 Fure com a broca adequada

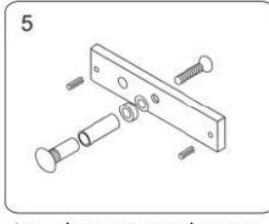

5 Instale a contraplaca na folha da porta

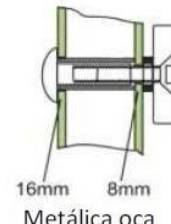

16mm 8mm
Metálica oca
Furo int. 8mm
Furo ext. 16 mm

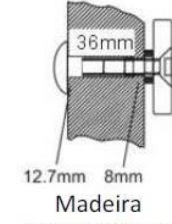

36mm
12.7mm 8mm
Madeira
Furo int. 8mm
Furo ext. 13 mm

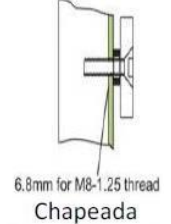

6.8mm for M8-1.25 thread
Chapeada
Furo int. 8mm

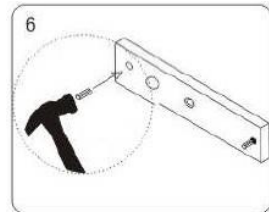

6 Coloque os pinos na contra-placa

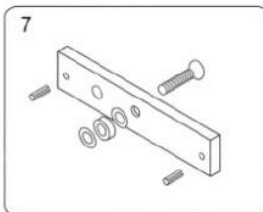

7 Coloque as anilhas na contra-placa de acordo com o desenho

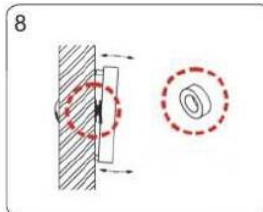

8 Coloque as anilhas entre a contra-placa e a porta

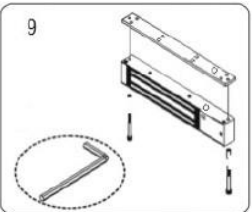

9 Use a chave sextavada para remover a placa de montagem

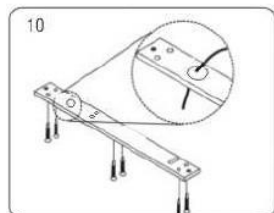

10 Passe o cabo pelo furo e aperte a placa no aro

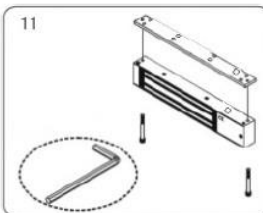

11 Aperte o corpo da fechadura à placa

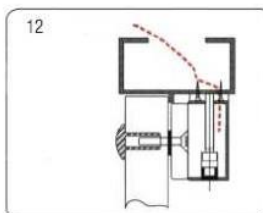

12 Feche e puxe a porta para testar a força de tração

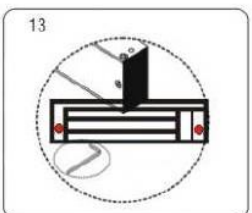

13 Reaperte os parafusos de fixação



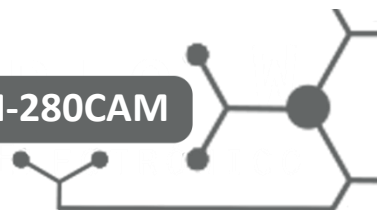

Instalação de esquadros

Esquadro em L

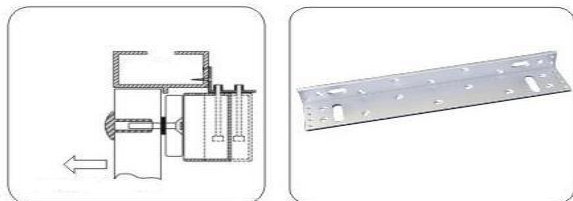

Quando o aro porta tem largura inferior a 42 mm ou a porta abre para fora é necessário instalar o esquadro L

Esquadro em ZL

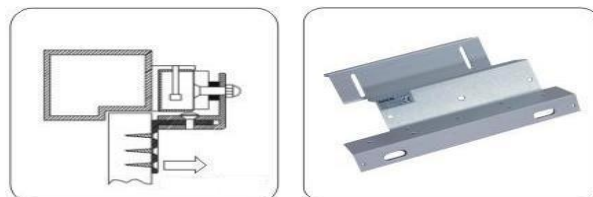

Quando a porta abre para o interior é necessário instalar o esquadro ZL

Esquadro em U

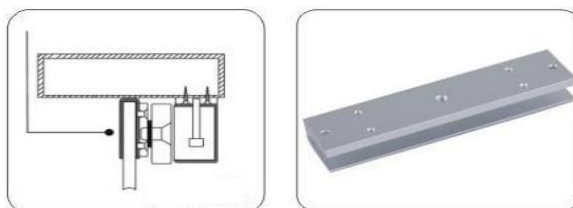

Para portas em vidro temperado de 10 a 15 mm de espessura é necessário usar a luva em U

Instruções de instalação

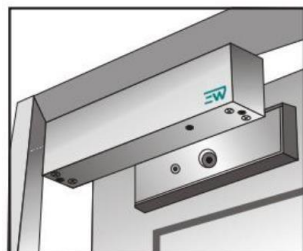

Fixação Directa

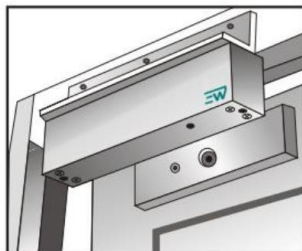

Esquadro L

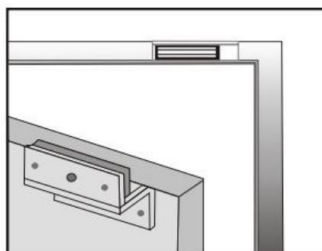

Esquadro ZL

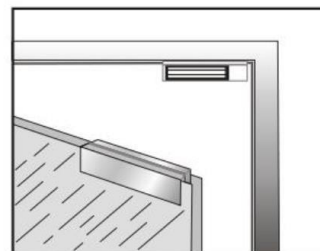

Esquadro U (vidro)





Configuração da Alimentação

Temporizador no fecho: 0, 3, 6 e 9 segundos. 0 segundos, por defeito

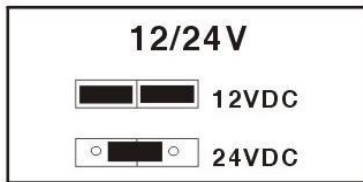

Configuração dos comutadores internos para 12 ou 24 VCD

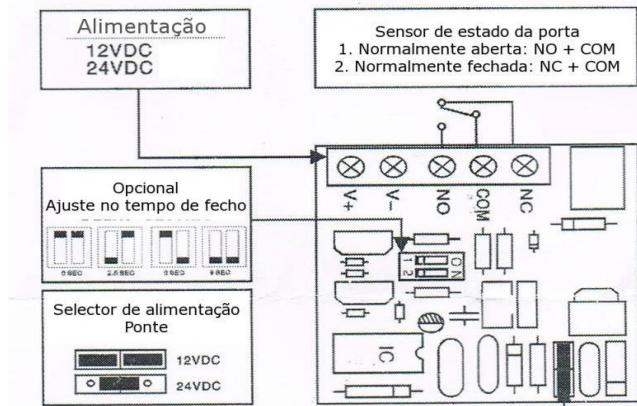

Localização dos comutadores na placa principal de YM-350T(LED)

Esquema eléctrico

Fechadura Electromagnética

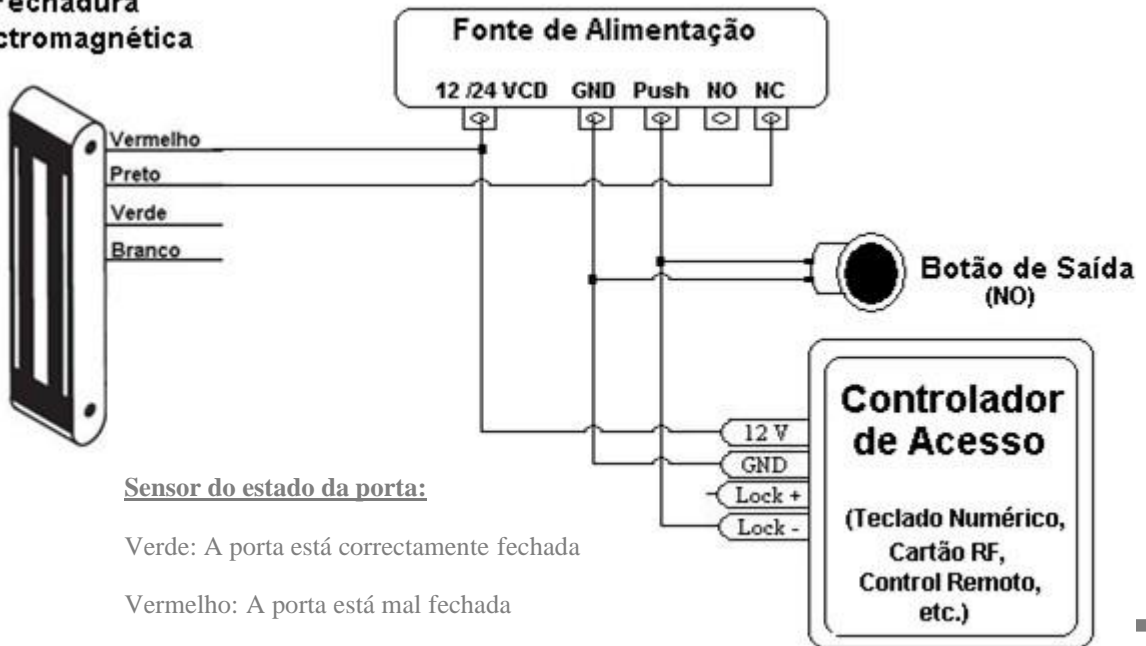

Sensor do estado da porta:

Verde: A porta está correctamente fechada

Vermelho: A porta está mal fechada

Sem luz: A porta está em uso ou sem corrente (porta aberta)

Gara

