



Triplow W



Smartphone-Controlled Electronic Lock



ATTENTION:

1. Keep mechanical keys in a safe place different from the lock installation place so that in emergency/breakdown cases the door can be opened mechanically.
2. Pay attention to the battery level to be able of replacing the batteries on time.
3. Carefully read the manual before any installation and keep it for future use.





Triplo W



Dimensions

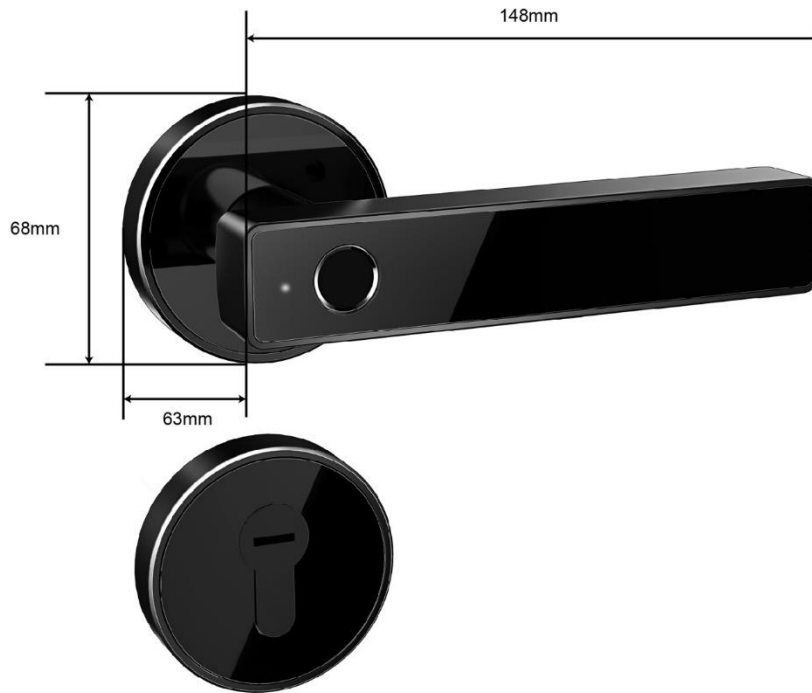

Types of Mortice /Mechanical Locks

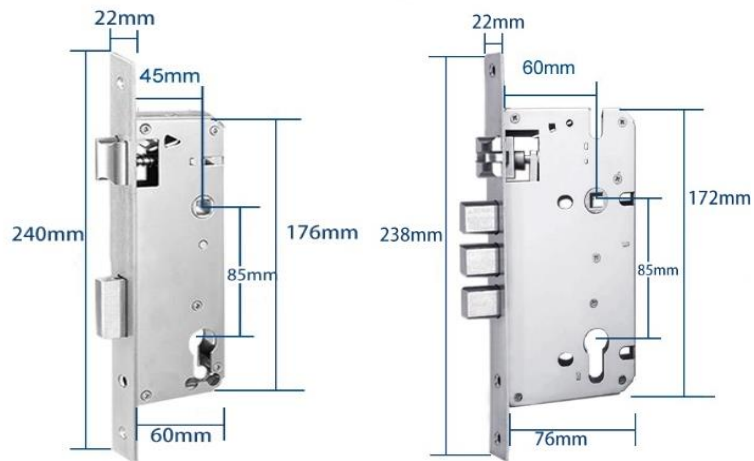

45*85	60*85 (security)
Metal/wooden doors	Metal/wooden doors





Installation

1.1 Installation Diagram

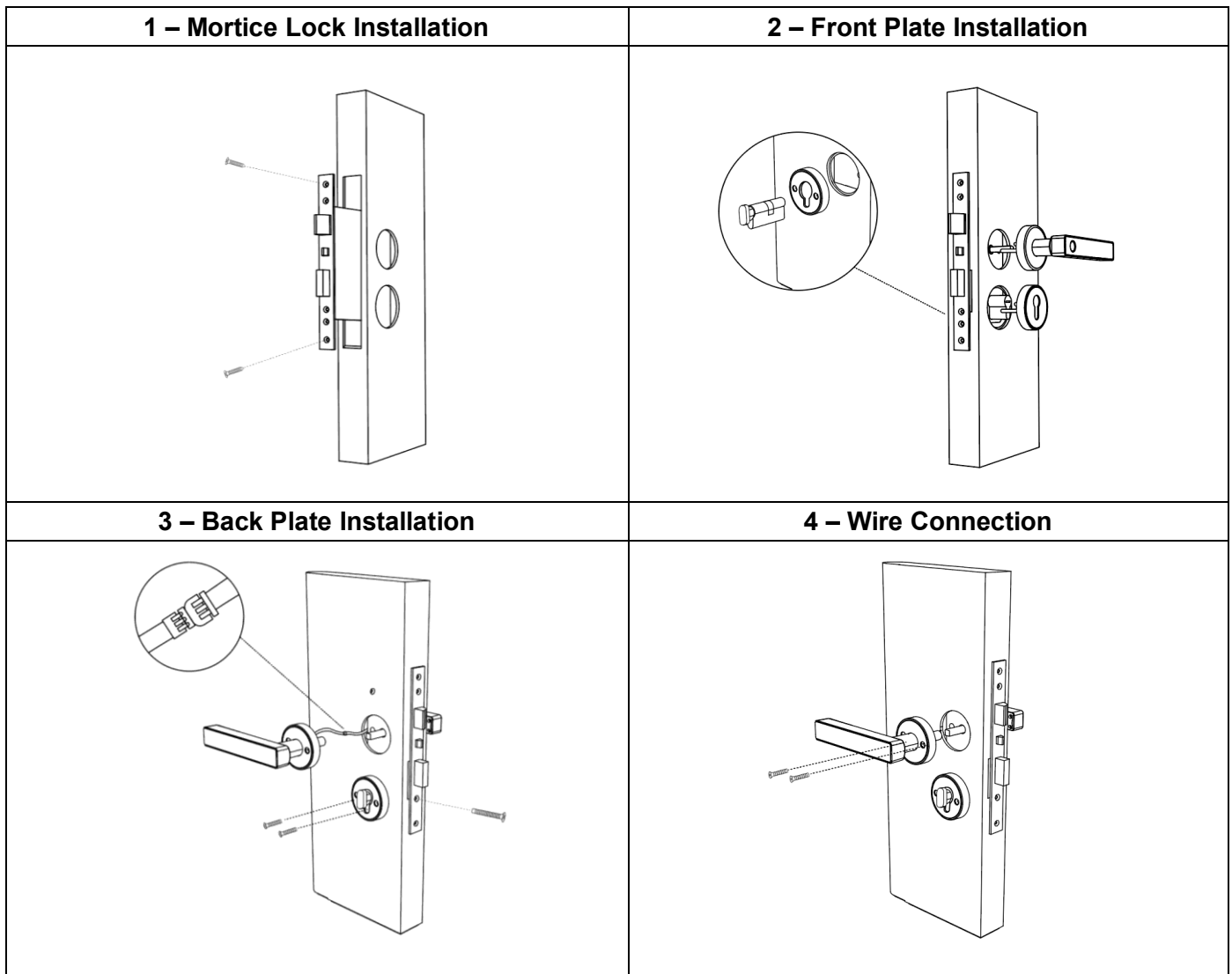



Technical Specifications

Models	TW21N FP
Material	SS304
Handle sizes	148*27
Opening Methods	Bluetooth Mechanical key Fingerprint
Colour	Silver Black
Door types	Metal/wooden door Sliding doors
Voltage/battery	6V/4x AAA
Door width	30-50mm
Data storage	Unlimited: management by APP
Operating temperature	-25°C +60°C
Operating humidity	20% ~ 90%
Voltage alarm	Less than 4.5V
Rejection percentage of digital fingerprint	<0.01%
Acceptance percentage of false digital fingerprint	<0.00003%





Lock initialization:

Open the battery compartment at the back panel and press the RESET button for 5 seconds.
(The RESET button is marked in an orange circle on the image).



Smartphone Application

TTLOCK application download

Download the app from the Play Store/App Store from your smartphone - Android or iOS (the following QR code can be used to be directed to the application).



Create an application account



The screenshot shows the registration interface with the following elements and annotations:

- 1**: A blue bar at the top contains "Iniciar Sessão" and "Registo". The "Registo" button is highlighted with an orange box.
- 2**: Below the bar, there are two radio buttons: "Telefone" (selected) and "E-mail". Both are highlighted with an orange box.
- 3**: The "País / Região" dropdown is set to "Portugal +351". Below it are input fields for "Número Telefone / E-mail", "Password entre 6-20 caracteres", and "Confirme a Password". The "Obter Código" button is highlighted with an orange box.
- 4**: At the bottom, there is a large grey "Registo" button highlighted with an orange box.

1. Press **Registration** to create an account.
2. Select the registration mode by **phone**.
3. Select the country of your telecommunication operator and after filling in the data click on **Get code**. You are going to receive a SMS with the validation code.
4. After entering the received code, click on **Registration**.





First Login

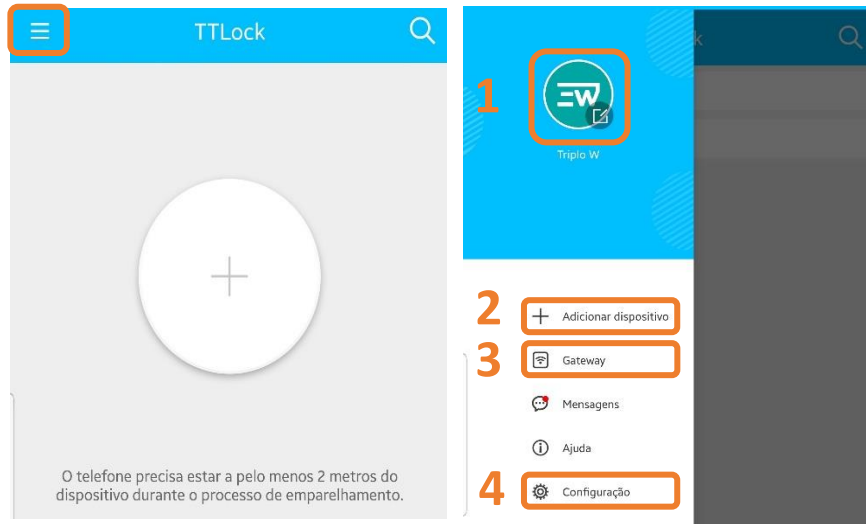

Click on the profile icon created, at the upper left corner, for the following options:

1. **Profile settings** – Profile picture, modification of access credentials or name, etc.
2. **Add lock** – Add a new access control.
3. **Gateway** – Add and manage TW-GATE devices.
4. **Settings** – Application settings and transfer of equipment to other accounts.

Add device

Make sure the device is connected to the power supply before starting the set up; it is recommended to perform a RESET.





Triplow



- 1 Press **Add device** or “+”.
- 2 Select **Lock**
- 3 Activate device (press fingerprint on the fingerprint sensor) or continuously press the RESET button until there is a sound signal followed by two beeps. Press **Next**.
- 4 Next, the application is going to search for the access control by Bluetooth:
 1. On the mobile app is going to appear the name and symbol + (if there is no symbol + the RESET must be carried out again).
 2. Press the symbol + to finish the initial synchronization.
- 5 Assign a name to the access control added and press **OK**.



Device management

Main device menu



The main device menu includes the following options:

1. Abertura pela aplicação
2. Adicionar utilizadores da aplicação móvel
Enviar eKey
3. Gerir utilizadores da aplicação móvel
eKeys
4. Adicionar Impressões digitais
Impressões digitais
5. Registos
6. Definições
Configuração
7. Abertura Remota (apenas com dispositivo TW-GATE)

The TTLock screen shows a large lock icon with a Bluetooth symbol. Below it, the text reads: "Toque para abrir, pressione longo para fechar." The bottom menu includes: Enviar eKey, eKeys, Impressões digitais, Registos, and Configuração.

Opening by the application/keypad

- Press the symbol 

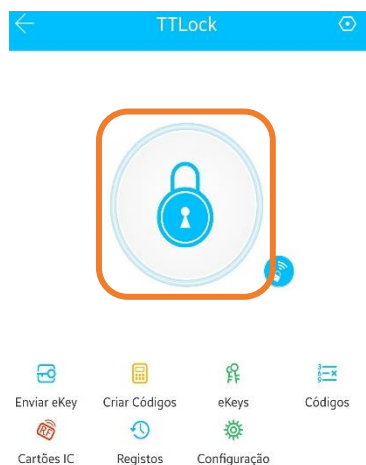

The TTLock screen shows the lock icon highlighted with an orange box. The bottom menu includes: Enviar eKey, Criar Códigos, eKeys, Códigos, Cartões IC, Registos, and Configuração.

Note: This function is only available by being next to the lock (locally) by Bluetooth.



Add fingerprints

- Select **Fingerprints**



- In order to record a fingerprint, you need to be close to the lock and wait for the synchronization and then, follow the application instructions.

Assigned fingerprint management



- **Fingerprint** – Management of fingerprints created until that moment. Fingerprints can be deleted if the entire process is carried out locally by using Bluetooth or by using the TW-GATE device.

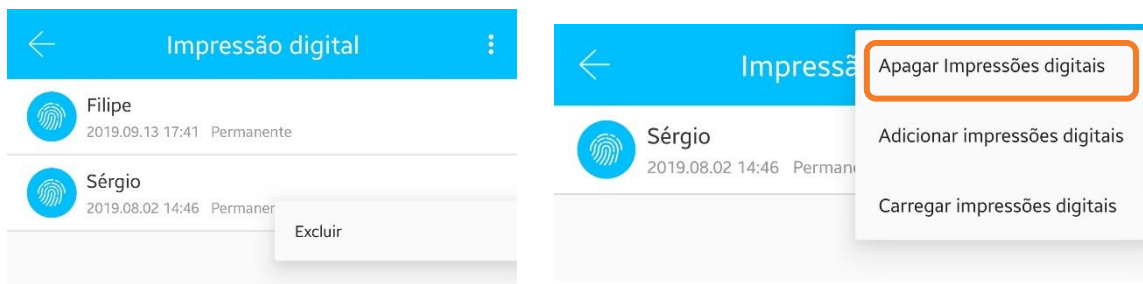

Delete fingerprint:
Continuously press the fingerprint to be deleted until the **Delete** option appears.

Delete all fingerprints:
Enter the menu at the right corner and press **Delete fingerprints**.



Opening records

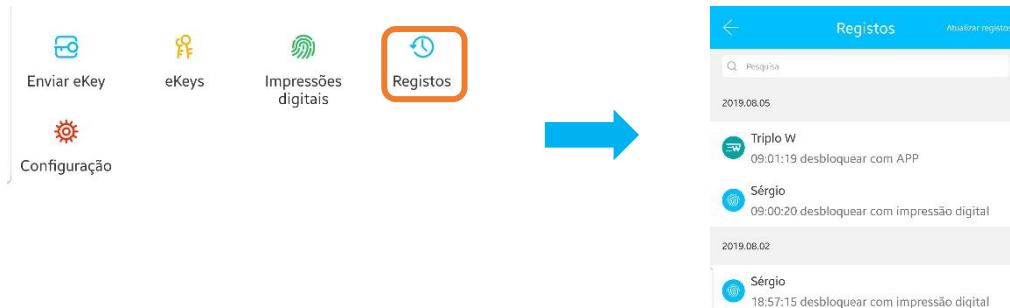

This entire process needs to be carried out locally, by Bluetooth or WIFI connection to the TW-GATE.

Device settings

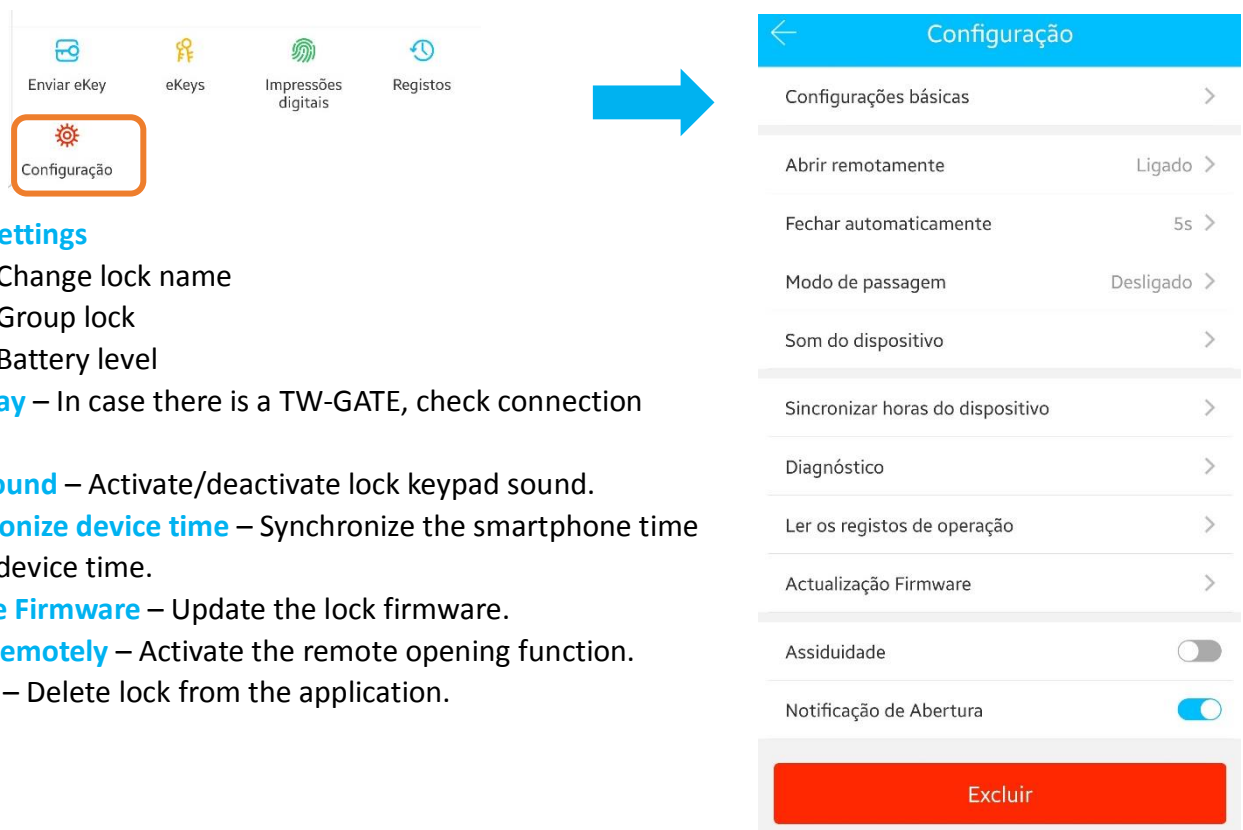

Basic settings

- Change lock name
- Group lock
- Battery level

Gateway – In case there is a TW-GATE, check connection status.

Lock sound – Activate/deactivate lock keypad sound.

Synchronize device time – Synchronize the smartphone time to the device time.

Update Firmware – Update the lock firmware.

Open remotely – Activate the remote opening function.

Delete – Delete lock from the application.

This entire process needs to be carried out locally by Bluetooth or WIFI connection to the TW-GATE.





Add Gateway (Optional)

Gateway Light Meaning



The gateway is connecting to the power supply.

- Intermittent blue/red light – The gateway is getting ready for pairing.
- Blue light – Connected to internet.
- Red light – Failure to connect to the network.

Pairing the gateway to the device

- 1. Enter the app**
- 2. Press "☰"**
- 3. Select "GATEWAY"**
- 4. Select "G2"**
- 5. Connect the Gateway to the power supply.**
- 6. Select "G2"**
- 7. WIFI network setting**
- 8. Fill in the data for the WIFI connection.**

9. After successfully adding the gateway, the application will automatically search for devices within the gateway's range.









Attention: If time is exceeded, disconnect the gateway from the power supply and connect it back again.

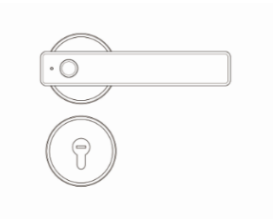
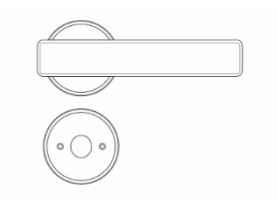

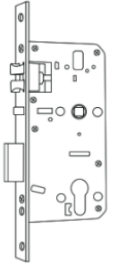

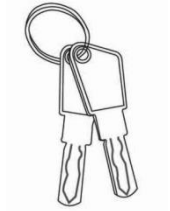
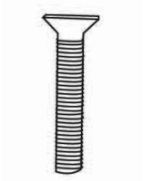
Triplow W



			
Front plate	Back plate	Instruction manual	Mortice lock
1	1	1	1
			
Mechanic cylinder	Mechanical keys	Fixing screw	Fixing screw for armature plate
1	2	4	4
			
Threaded connector nut (different sizes)	TW-GATE (optional)		
8	4		





Warranty

13

Client Name: _____

Client Phone number: _____

Purchase Date: _____

Product: _____

Model: _____

Note:

- 1) Please keep this manual in order for you to use it when the warranty service is needed.
- 2) Warranty has a two-year validity from the purchase date.
- 3) Equipment is protected against manufacturing defects by the warranty, with a two-year validity from the purchase date.
The warranty does not have a coverage for breakdowns caused by a misuse of the system, by a poor electric installation not checked by Triplo W., by natural disasters such as: storms, floodings or other similar, nor by the replacement of wear components depending on use.

Seal and Signature from Dealer

