

# INSTALLATION MANUAL

DSW-60

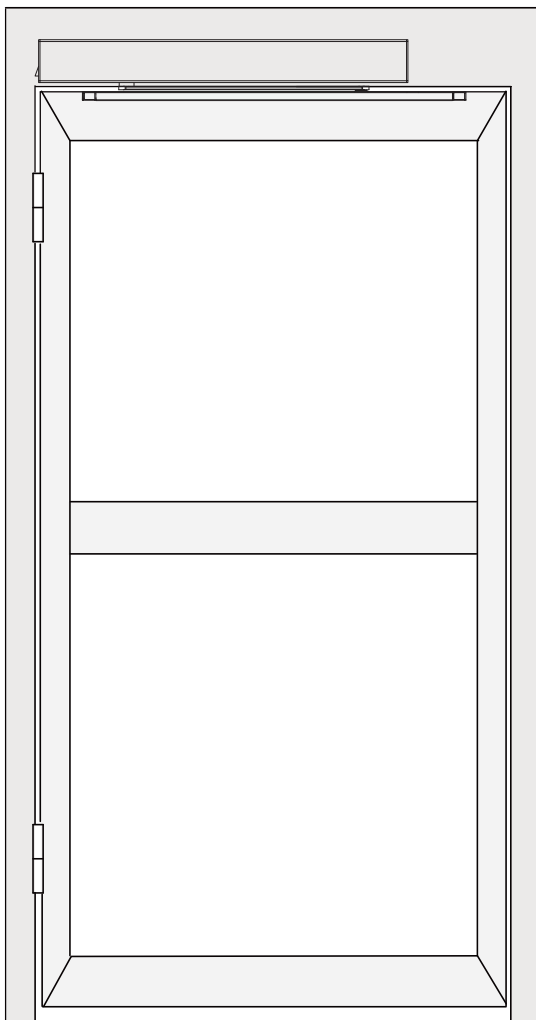

**AUTOMATIC ENTRANCE SPECIALISTS**

# Contents

Chapter 1	Technical parameters .....	3
Chapter 2	Components description.....	4
Chapter 3	Mechanical installation(pull arm).....	5-8
Chapter 4	Mechanical installation(push arm) .....	9-11
Chapter 5	Electrical connection .....	12-14
Chapter 6	Parameters adjustment .....	15-16

## About this manual

Use this manual as a guide. The photos, graphs, charts and illustrations provided in the manual are for the purpose of explanation and description only, there may be differences with the specific products, please refer to the actual product. Due to product version upgrade or other needs, our company may update this manual. If you need the latest version of the manual, please contact us.

We recommend that you use this manual under the guidance of professionals.

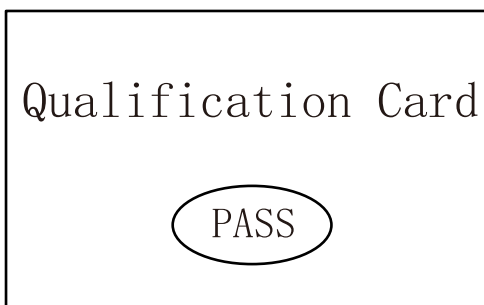





This product should not be discarded after the expired date or not workable with maintenance. Please hand it over to the company qualified for the disposal of waste electrical and electronic products. For the correct method, please refer to the national or local regulations on the disposal of waste electrical and electronic products.

## Preface

The purpose of this section is to ensure that the user can use the product correctly through this manual to avoid danger or property damage during operation. Before using this product, please read the product manual carefully and keep it for future reference.

### Notation descriptions:

For symbols that appear in this manual, the descriptions are as below:

Symbols	Descriptions
 Remark	Expressing supplements and explanations for the main text.
 Note	Alert the user about some important operations or to prevent potential injury and property damage.
 Warning	Indicates potential risks, which, if not avoided, could result in injury, equipment damage, or work interruption.
 Danger	Indicates high potential risks which, if not avoided, could result in a substantial risk of personal injury or death.

### Precautions for safe use:

#### Warning :

1. During the installation and use of this product, must strictly comply with all electrical safety regulations of the country and region.
2. Please disconnect the power supply during wiring, disassembly and other operations, don't operate with electricity to avoid contact with exposed circuits.
3. If the device is not working properly, please contact the store where the device was purchased or the nearest service center and please don't disassemble or modify the device in any way.  
(Factory isn't responsible for problems caused by unauthorized modifications or repairs.)

#### Note :

1. Please avoid to drop objects on this device and avoid to vibrate the device strongly, and keep the device away from the places with magnetic field interference.
2. Avoid installing the device where the surface is subject to vibration or shock.
3. Please don't use the device in a high temperature, low temperature or high humidity places. For specific temperature and humidity requirements, please refer to the parameter table.
4. The equipment should be used indoors, shouldn't be installed in places where it may be exposed to rain or very humid.
5. Don't operate in an explosive environment.
6. Don't place the device in an environment with corrosive gas, the gas will damage the device.
7. Please don't stay in or put obstacles in the range of the door opening or closing for a long time. When the door is opening or closing, please don't use your body or obstacles to stop it. Our company is not responsible for any damage caused in any way.

## Chapter 1 Technical parameters

### 1. Technical parameters

Power: 220V/AC  $\pm 10\%$ , 50/60Hz

Power consumption: max.75W, standby 3W

Drive unit: 24V DC motor

Anti-Squeeze Device: Standard

Opening angle:  $80^\circ$  -  $100^\circ$

Opening time (speed): 3-7S adjustable

Closing time (speed): 3-7S adjustable

Open hold time: 0.5-30S adjustable

Drive arm: Pull arm

Environment temperature:  $-20^\circ\text{C}$ - $45^\circ\text{C}$

Relative humidity:  $\leq 85\%$

### 2. Suitable for door Width and Weight

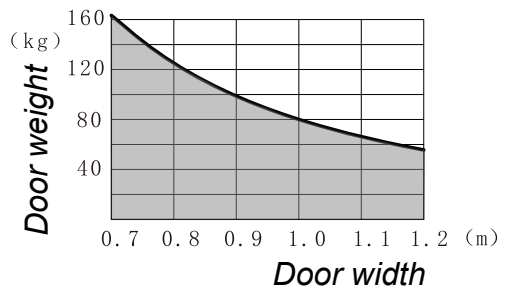

### 3. Dimension

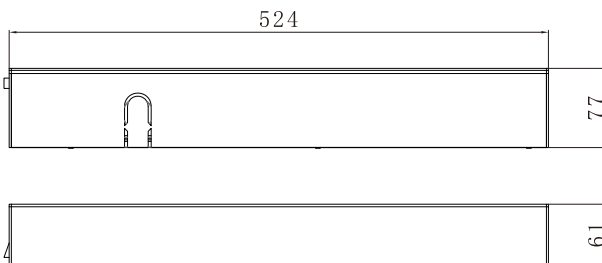

## Chapter 2 Components description

holes for cables

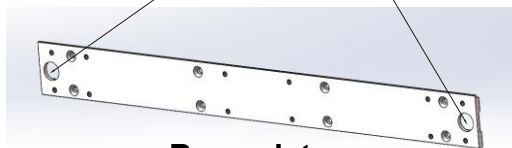

**Base plate**

Power socket

Motor

Controller

Output shaft

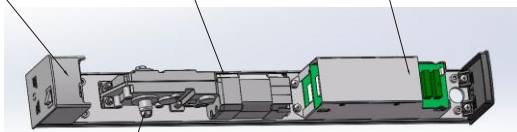

**Drive unit**

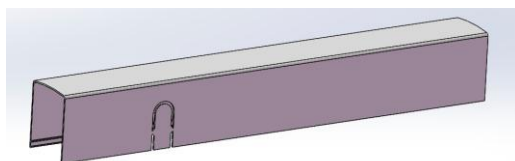

**Front cover**

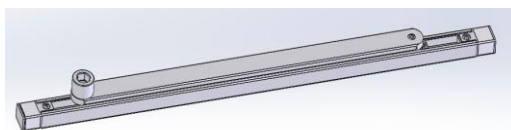

**Pull arm**



**Push arm**

## Chapter 3 Mechanical installation(pull arm)

### 3.1. Installation example

Suitable for the door leaf open inward  
(the drive unit is fixed inside of the room)

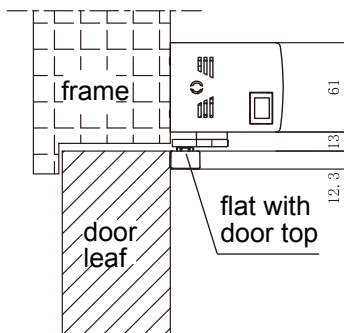
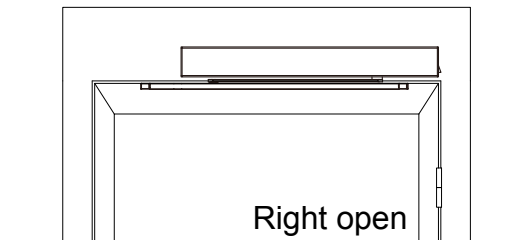
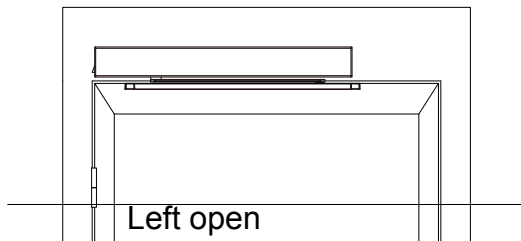

### 3.2. Installation of base plate

flat with the vertical edge of the door

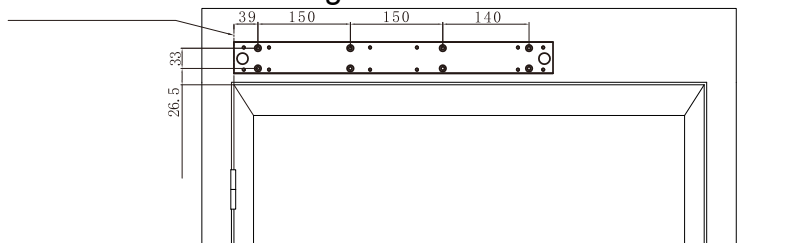

### 3.3. Installation of pull arm

flat with the top edge of the door

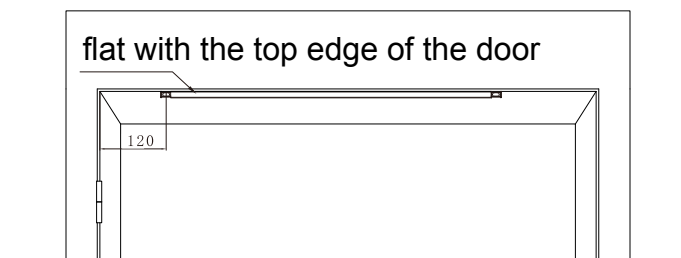

Move the stopper to adjust the door opening angle (the stopper is on the left when left opening)

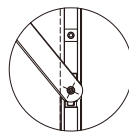

e.g. Right open



### 3.4. Installation of drive unit

Determine the direction of the output shaft of the drive unit according to the door opening direction. Use needle-nose pliers and other tools to break open the baffle on one side of the cover; then use a long-handled tool such as a screwdriver to pry open the cover from here.

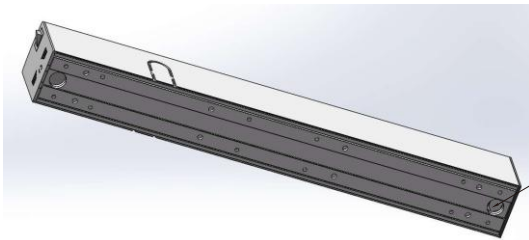
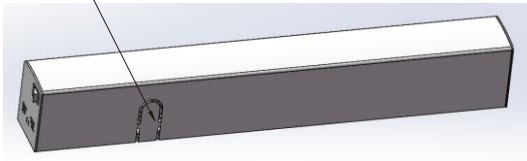

Use a long-handled tool such as a screwdriver to push open the cover from here (**only here!**).

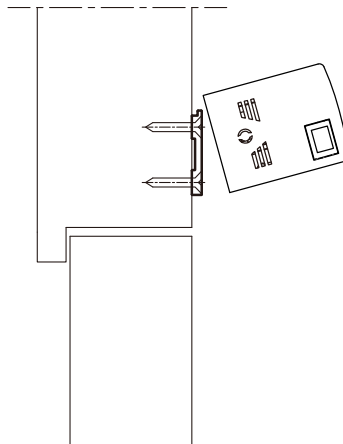

### 3.5. Installation of front cover

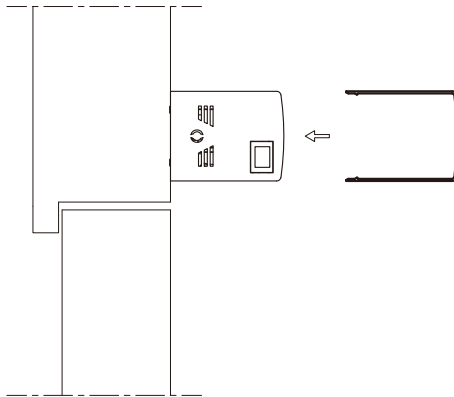

### 3.6. Connection of drive unit and pull arm

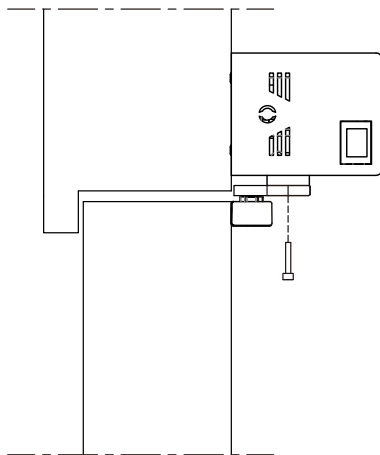

## Chapter 4 Mechanical installation(push arm)

### 4.1. Installation example

Suitable for the door leaf open outward  
(the drive unit is fixed inside of the room)

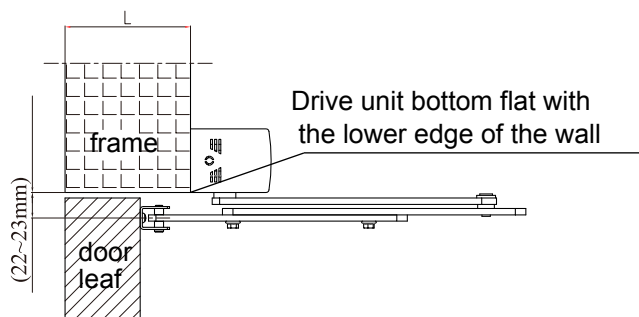
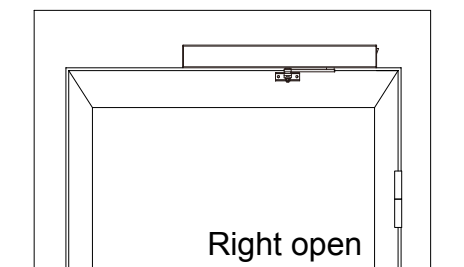
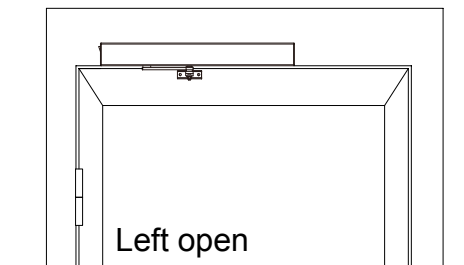

Wall thickness  $L = 0\sim 210\text{mm}$

## 4.2. Installation of base plate

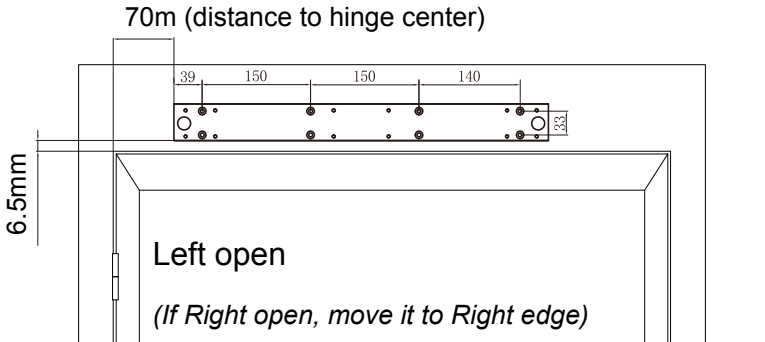

## 4.3. Installation of push arm

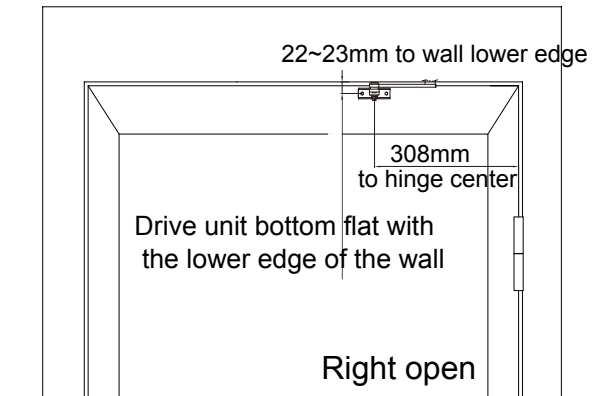

The push arm fixing seat is fastened to the door leaf with two round head wood screws according to the size shown in the diagram.  
( If for steel door, fasten the fixing seat with M6x15 cross head screws).

## Automatic swing door operator \* Installation guide

---

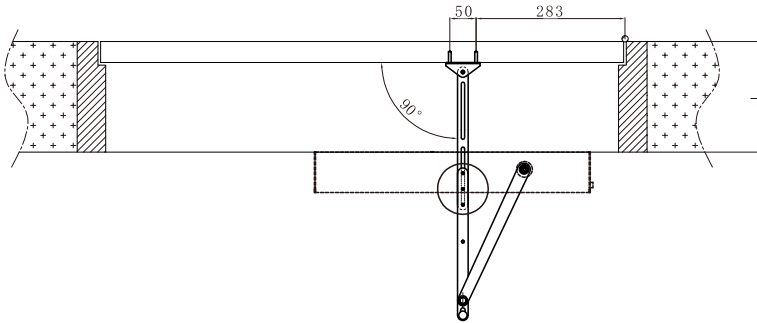

Loosen the four tightening bolts to adjust the length of the push arm according to the depth "L" of the door frame, make the angle between the push arm and the door leaf is  $90^\circ$  as shown in below diagram.

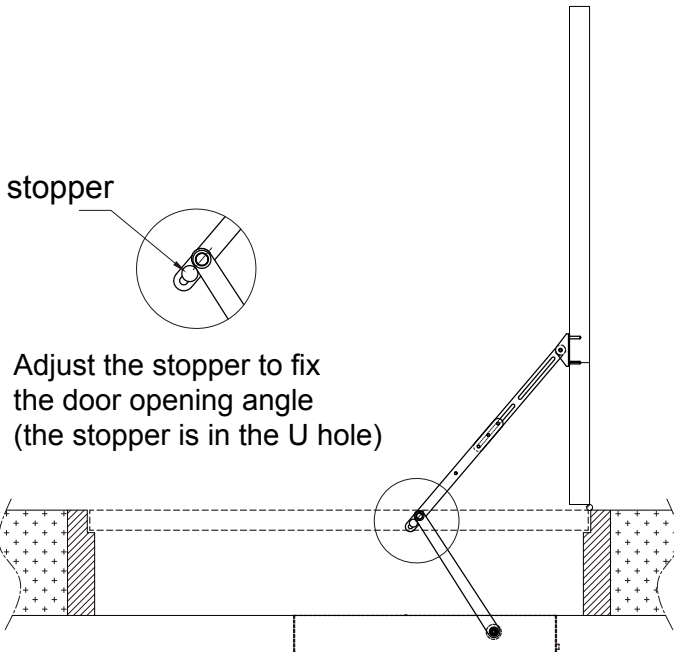

## Chapter 5 Electrical connection

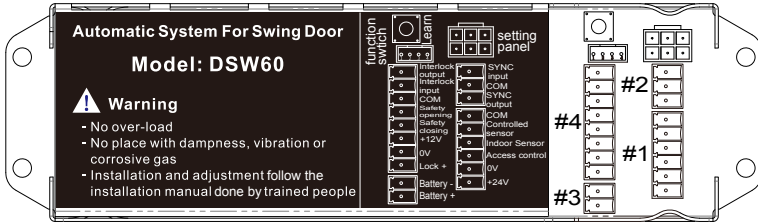

Automatic System For Swing Door

Model: DSW60

**Warning**

- No over-load
- No place with dampness, vibration or corrosive gas
- Installation and adjustment follow the installation manual done by trained people

function switch

setting panel

#4  
#2  
#1  
#3

- #1
- COM
  - Controlled sensor
  - Indoor sensor
  - Access control
  - 0V
  - +24V

The "+24V" and "0V" ports are DC 24V voltage output, and the total output power is not more than 25W;  
When a signal is input between the "Controlled sensor" and the "COM", the door opens;  
When a signal is input between "Indoor sensor" and "COM", the door opens;  
When a signal is input between "Access control" and "COM", the door opens;  
**Note: When the function switch is set to "Exit" mode, the "Controlled sensor" signal is shielded; when the function switch or remote control is set to "Lock" mode, both the "Controlled sensor" and "Indoor sensor" signals are shielded.**

- #2
- SYNC input
  - COM
  - SYNC output

When the dual-door synchronization function needs to be used, after the two doors have been debugged, set the master door " n1: 02, n2: Z ", the slave door " n1: 02, n2: C ", and connect the synchronization port:  
Master door "SYNC input" with the slave door "SYNC output" ,  
"COM" of the master door with the "COM" of the slave door ,  
Master door "SYNC output" with the slave door "SYNC input" .

- #3
- Battery -
  - Battery +

The backup battery is an emergency power supply, and a 24V DC power supply with a charging current of less than 800mA is selected as the backup battery.

- #4
- Interlock output
  - Interlock input
  - COM
  - Safety opening
  - Safety closing
  - +12V
  - 0V
  - Lock+12V

When you need to use the double door interlock function (that is, the other door is allowed to open only after one door is fully closed), you need to connect the interlock ports: the "Interlock output" of one door with the "Interlock input" of the other door, " COM" is connected with each other.  
**Safety opening:** During the door opening process, a closed signal is input between the "Safety opening" and the "COM", the door stops, when this signal is disconnected, the door continues opening;  
**Safety closing:** During the door closing process, a closed signal is input between "Safety closing" and "COM", the door will reopen;

The "+12V" and "0V" ports are DC 12V voltage output, and the total output power is less than 10W together with the electric lock port. "Lock +" and "0V" output voltage DC12V, when the remote control or the function switch is set to "Lock", Or the parameter " L " is set to "Auto lock" ( Lock every time while the door closed), output or cutoff DC12V voltage (according to the electric lock type parameter C, when it is set to " E " cathode lock, the DC12V will be removed when the door leaf is closed; when it is set to " P " anode lock, the DC12V is provided when the door leaf is closed.

## Remote control

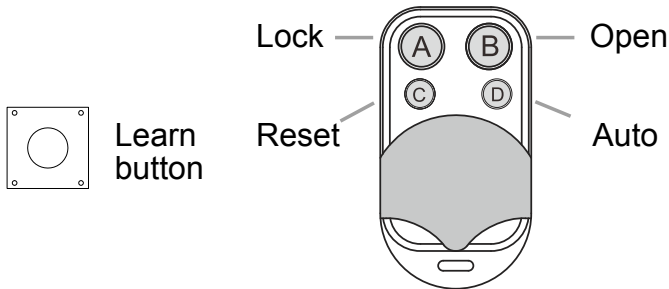

Instructions for code matching between remote control and drive unit controller:

1. Delete: long press the "Code" button until the buzzer sound stop, release the button.
2. Code matching: Click the "Code" button, the buzzer will beep. At this time, press any button on the remote control, and the buzzer stops beeping, indicating that the code matching is successful.

**When using the remote control, the buzzer will beep for 2 seconds.**

3. Remote control button function:

A: Lock: the "sensor" signals are shielded, and the door will be locked when fully closed;

B: Open: the door is kept open;

C: Reset: back to normal state;

D: Auto: Press it , the door will open and close one time.



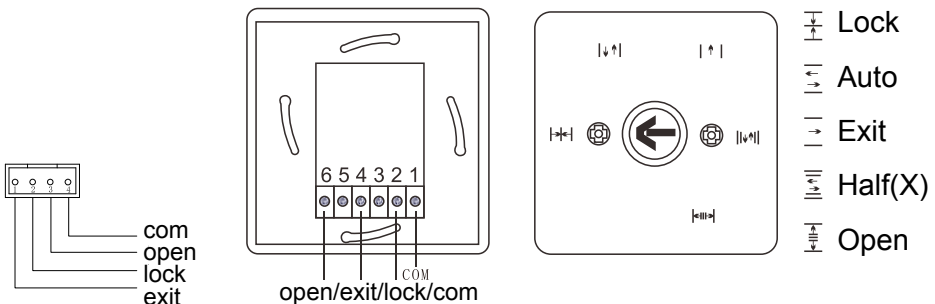

## Function switch



## Logical relationship between signals

Note: "Function switch" and "Remote control" both are used for door state setting, generally choose one of them.

In the state of using the "Function switch":

Signal F-switch	Controlled sensor	Indoor sensor	Access	E-lock value (door closed)
 Eixt	×	✓	✓	✓
 Lock	×	×	✓	✓
 Open	×	×	×	×
 Auto	✓	✓	✓	×

In the state of using the "Remote control":

Signal R-control	Controlled sensor	Indoor sensor	Access	E-lock value (door closed)
Open	×	×	×	×
Lock	×	×	✓	✓
Reset	✓	✓	✓	×



## Chapter 6 Parameters adjustment

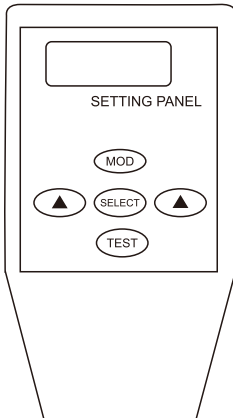

Connect the setting panel to the door controller, and adjust the parameters:

MOD: Press "MOD" key to enter the menu selection interface

▲/▼: Menu switching, parameter increase/decrease

SELECT: Confirm

TEST: test the running status of the door after the parameter setting is completed.

# Automatic swing door operator \* Installation guide

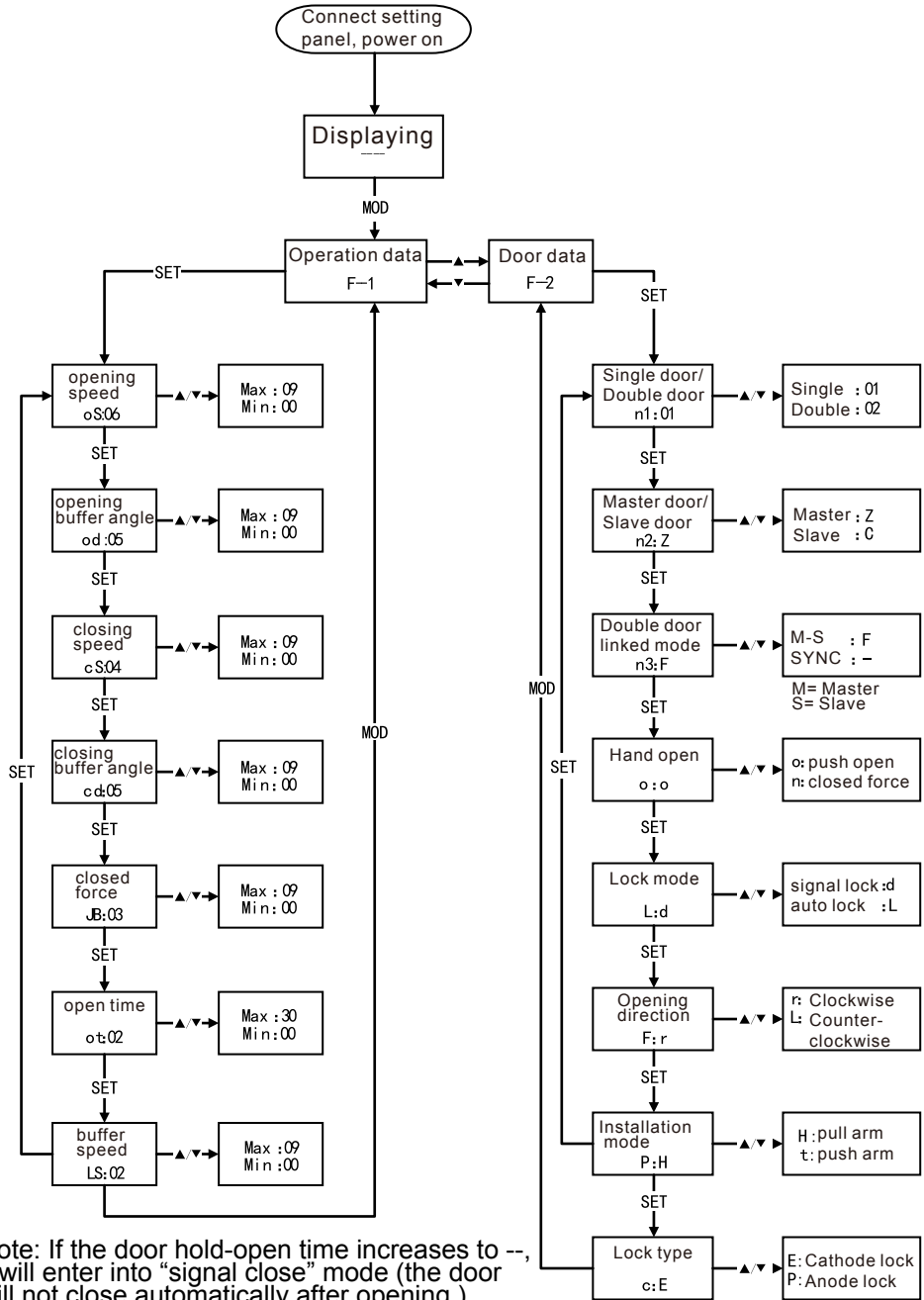

Note: If the door hold-open time increases to --, it will enter into "signal close" mode (the door will not close automatically after opening.)

