

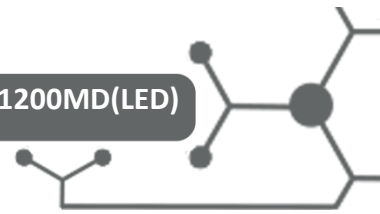

Triplow

YM-1200MD(LED)



FICHA TÉCNICA

Fechadura Electromecânica com cilindro



- Modelo: YM-1200MD(LED)
- Dimensões: 450 X 30 X 41.5 (mm)
- Voltagem: 12-24VDC
- Corrente: 800mA
- Sinal saída: sensor de porta NO/COM, sensor de fecho NC/NO/COM
- Led: fechado sinal vermelho, aberto sinal verde
- Força de tracção: 2000kg
- Temperatura de funcionamento: -20°C~+60°C
- Humidade de funcionamento: 0~95%
- IP: 65
- Adaptável para: portas de madeira, portas de metal, portas corta-fogo
- Predefinição de tempo de fecho automático: 0,3,6,9 segundos
- Distância máxima: 8mm



Triplo W

YM-1200MD(LED)

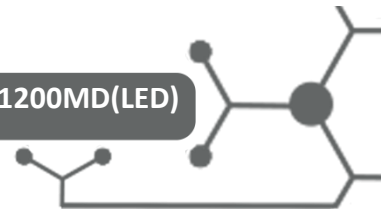

Dimensões

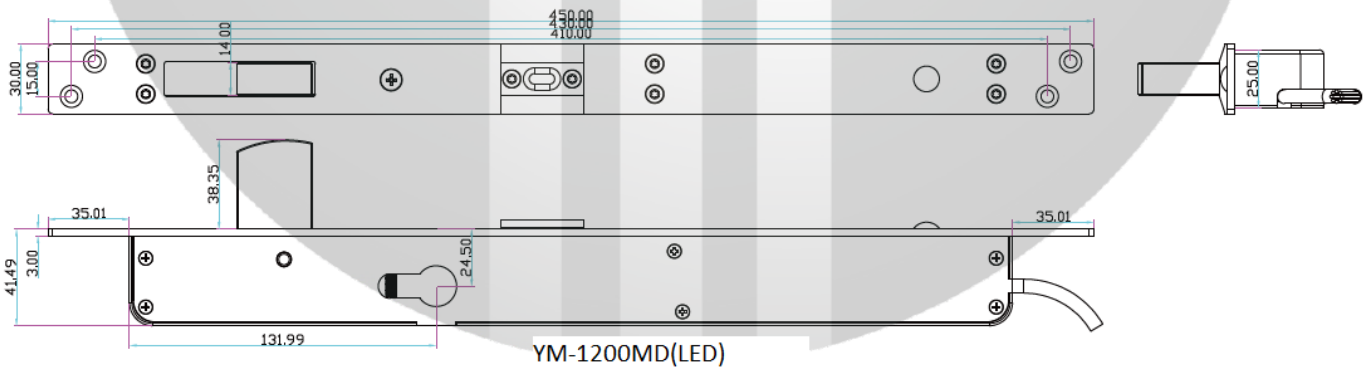

YM-1200MD(LED)

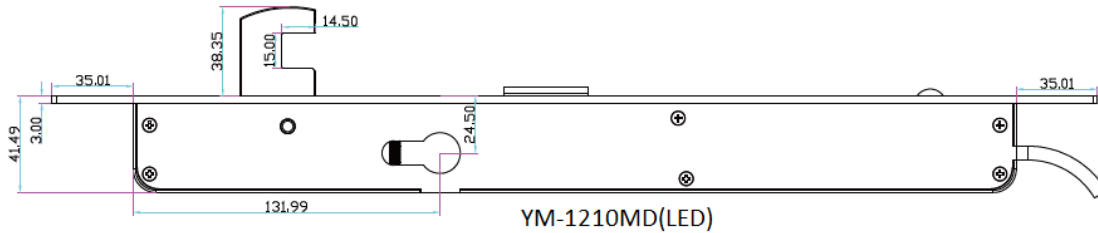

YM-1210MD(LED)

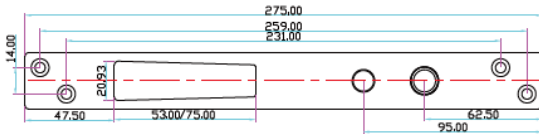

75mm na YM-1200MD(LED) e 53mm na YM-1210MD(LED), as restantes medidas são iguais nos dois modelos

Instalação

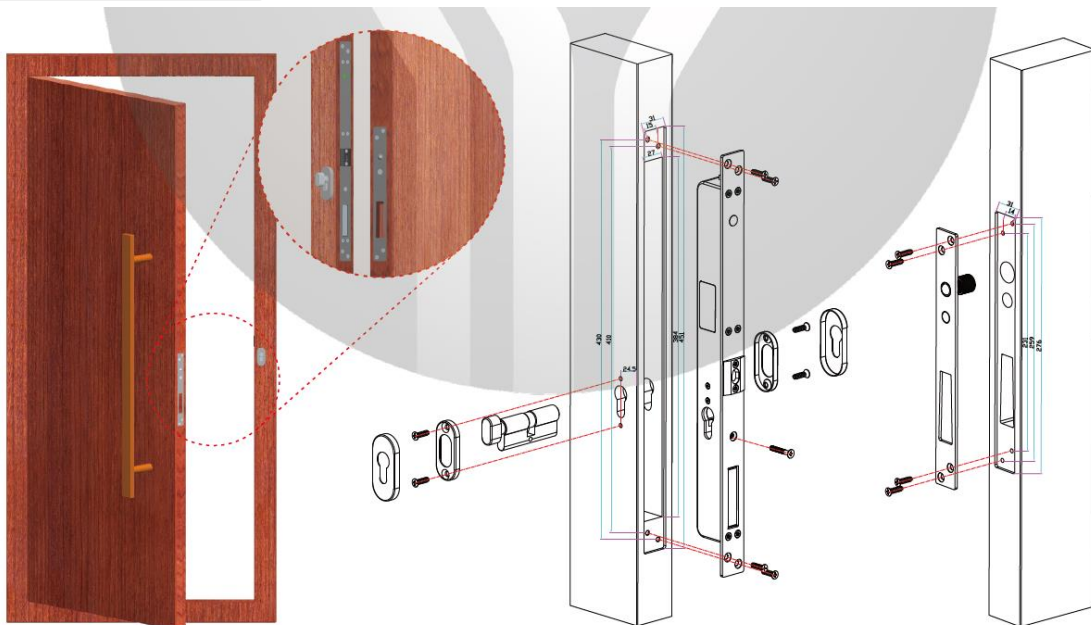



Triplo W

YM-1200MD(LED)

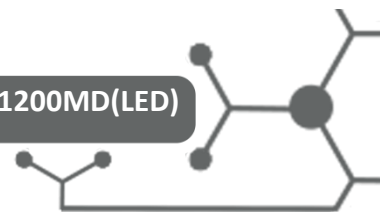

Temporizador de fecho Automático



Esquema de Ligações

