



Triplow

YB-500 A/B



DATA SHEET AND CONNECTION INSTRUCTIONS FOR THE YB-500

Parameters

Model	YB-500A
Latch	192L x 25W x 37H
Armature Plate	100L x 25W x 3H
Cover Plate	215L x 40W x 0.5H
Bolt	12.6 mm diameter, 17 mm long
Output Signal	NC/COM
Timer	0/3/6/9 seconds
Voltage	12 VDC
Current	Operation 900mA, Standby 120mA
Operating Mode	PCOP (fail safe)/POOP (fail secure)
Suitable for	Wooden doors, metal doors
Weight	0.65 Kg

Line Colours	Specifications
Red	+ 12 VDC
Black	- GND
Orange	OPEN
Green	NC
White	COM

Dimension

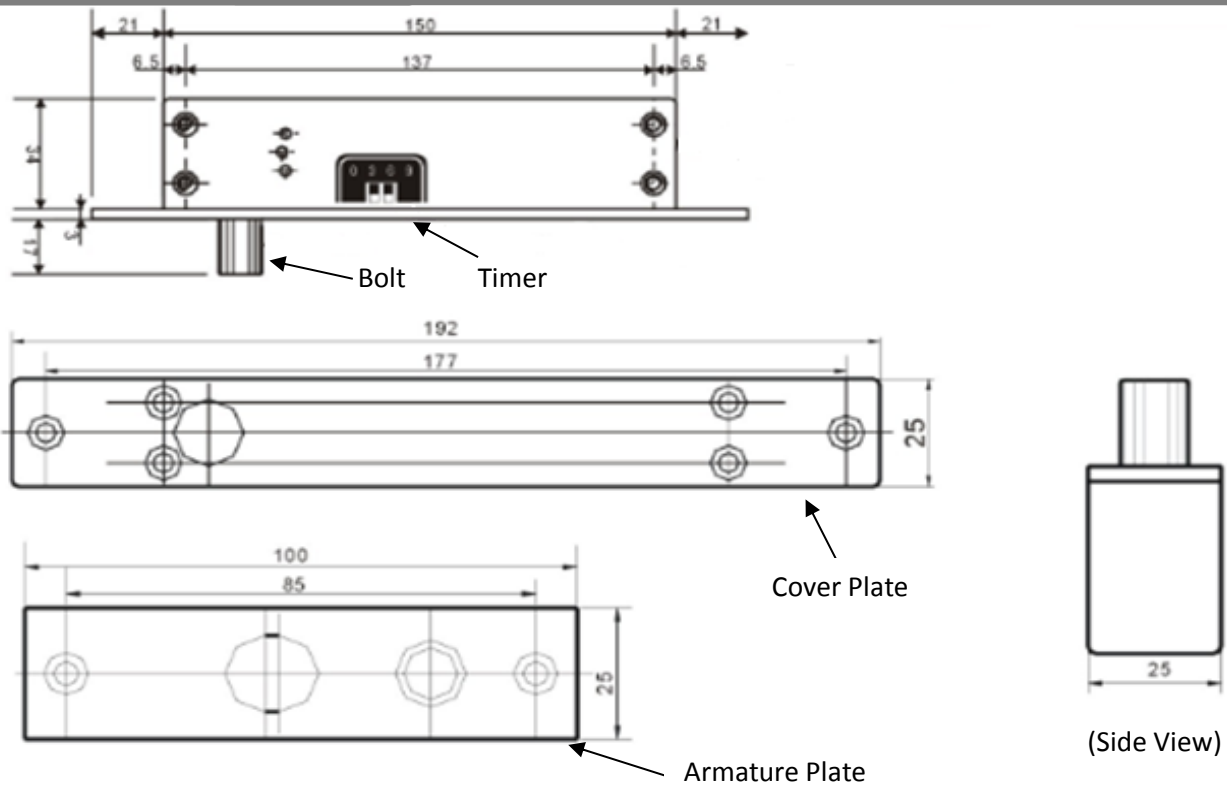



Triplow W

YB-500 A/B



Features

- Low operating temperature, safe and durable.
- Low power consumption.
- Autolock time delay of 0, 3, 6 and 9 seconds.
- Certificates: CE, MA.
- Stainless steel frontal plate.
- 12.6 mm diameter and 17 mm long tempered rounded steel.
- Tested for 500000 cycles.

Installation

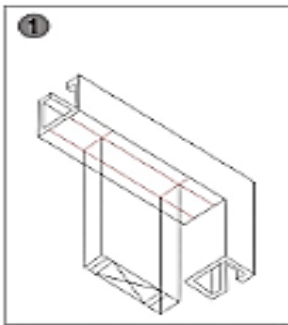

1 Place the lock body at the centre line of the door frame.

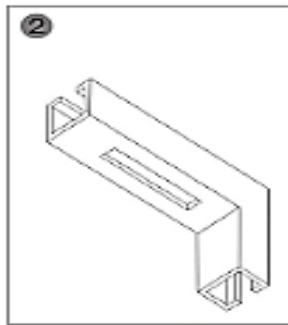

2 Cut the hole.

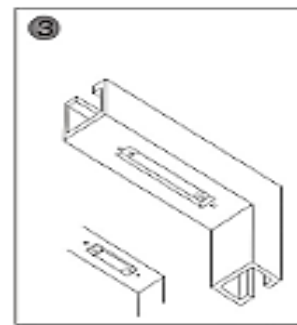

3 Drill the door frame according to mounting plates and screw the armature plate to the door.

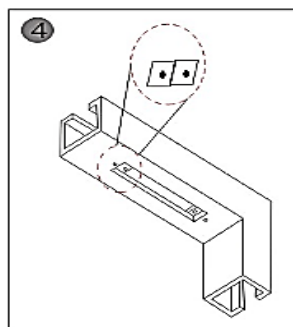

4 Screw mounting plates to the door frame.

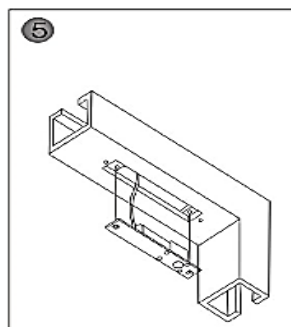

5 Mount the lock body to the door frame and test the operation.





Triplow W

YB-500 A/B



Timer Setting

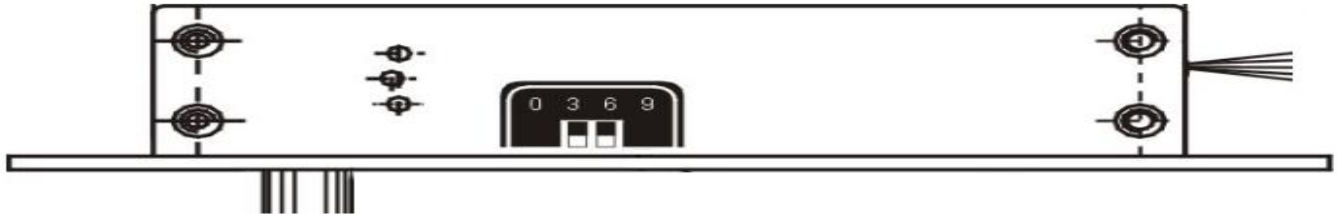

Timer setting to 0 seconds.



Timer setting to 3 seconds



Timer setting to 6 seconds.



Timer setting to 9 seconds.

ATTENTION: For a proper operation of the equipment use the timer only at 3, 6 or 9 seconds. If the following connection diagram is used, then set the timer at 3 seconds.





Triplow



Warranty

Every product marketed by Triplow Lda., have a two-year warranty for manufacturing defects. Every equipment sold is checked at our facilities for defects; and if it is unrepairable, it shall be replaced with a new product, according to the corresponding warranty.

For additional information check our conditions of sale at:

<https://www.triplow.pt/loja/termos-e-condicoes>

