

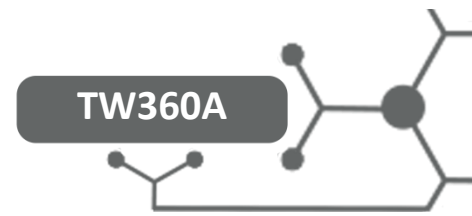

Triplow W



FICHA TÉCNICA



TW-360A

Trinco Eléctrico para Barra
Anti-pânico

- Modelo: TW360A
- Fail-Secure (Sem alimentação porta fechada)
- Voltagem: 12 VDC

Dimensões

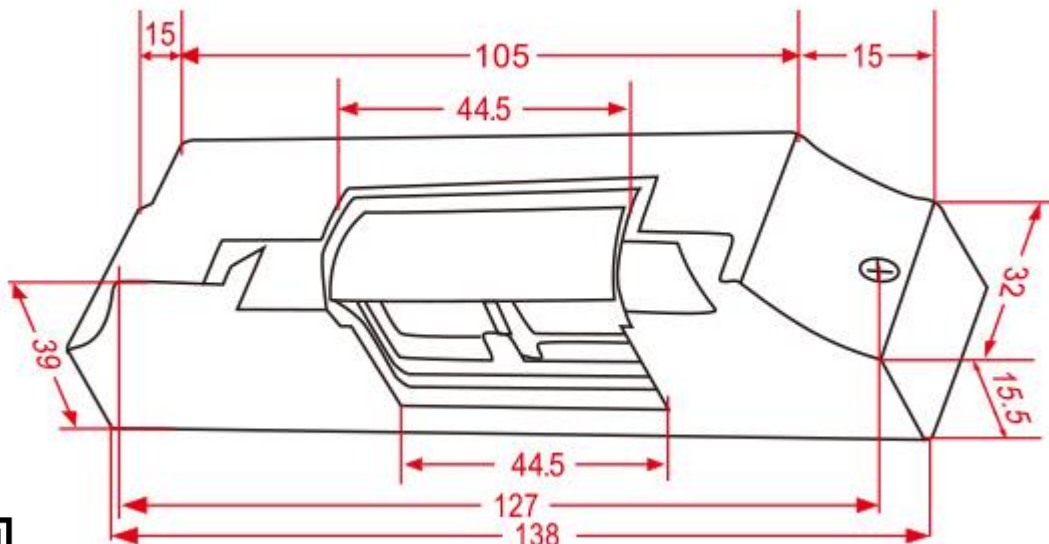

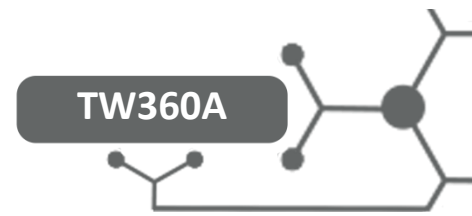

Montagem

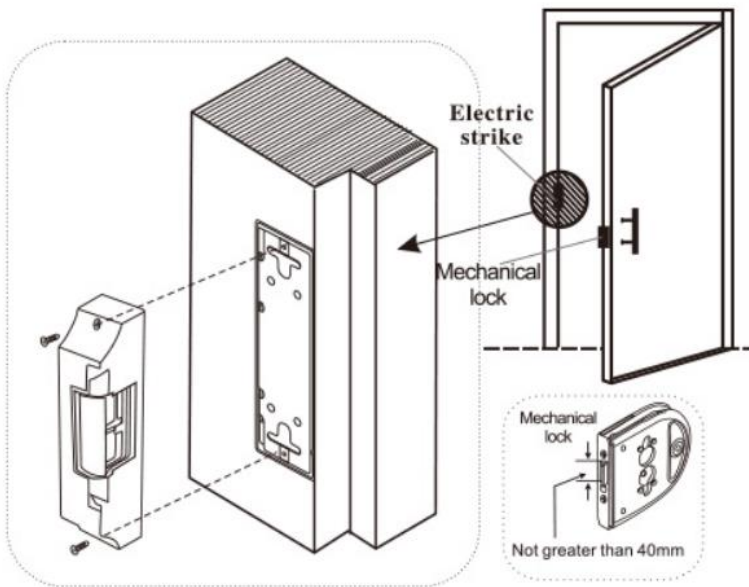
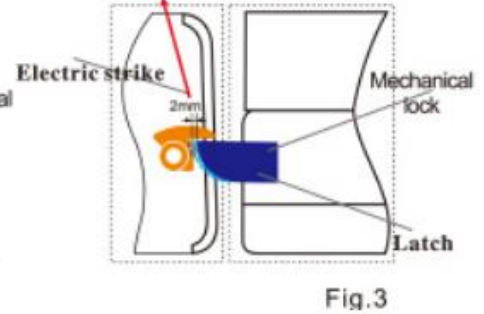
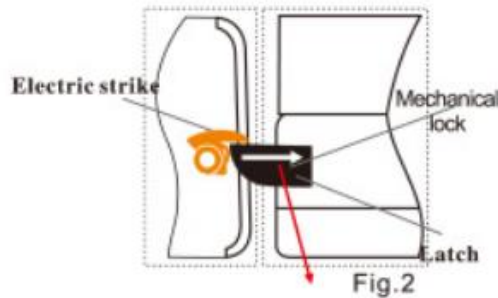
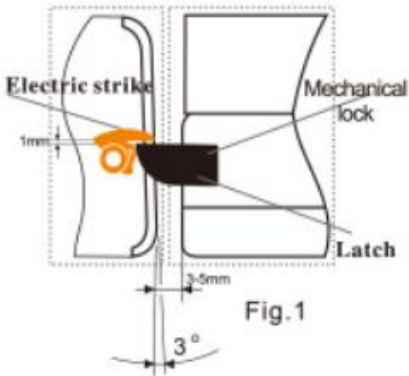

Instruções:

1. Mantenha uma distância de 1-2mm entre o trinco eléctrico e a fechadura mecânica (fig.1)
2. Mantenha uma distância de 3-5mm entre o trinco eléctrico e o espelho da fechadura mecânica (fig.1)
3. A força de resistência da fechadura mecânica não deve ser superior a 3N (fig.2)
4. A parte da língua da fechadura mecânica inserida no trinco eléctrico deve ser superior a 2mm (fig.3)

