



Electroímãs (280kg)

Especificações

Modelo	Tamanho (mm)	Voltagem	Corrente	Força Retenção (kg)	Tipo Sinal	Tempo	Porta
YM-280T(LED)	250Lx48.8Wx27.9H	DC12V ou 24VDC	12V/500mA ± 10% 24V/250mA ± 10%	280 kg	NO/NC/COM	0/3/6/9 sec.	Porta Simples
EM-280DS(LED)	500Lx48.8Wx27.9H	DC12V ou 24VDC	12V/500mA ± 10% x2 24V/250mA ± 10% x2	280 kgx2	NO/NC/COM	No	Porta Dupla

Dimensões (mm)



YM-280T(LED)

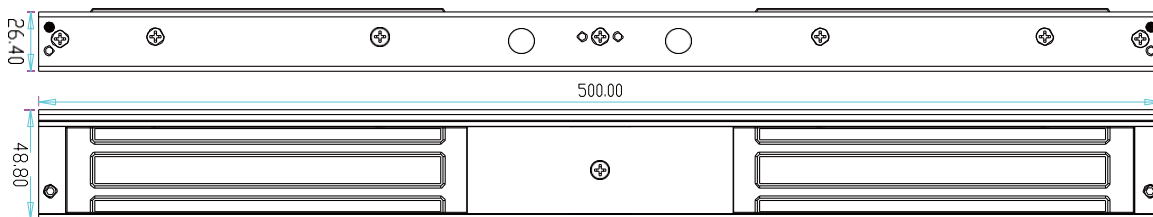
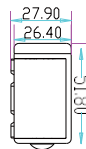

EM-280DS(LED)

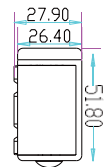

Esquema Eléctrico

Sinal Porta	
Vermelho	NC
Amarelo	COM
Preto	NO

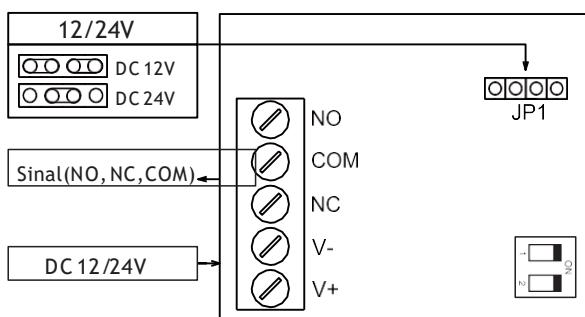

O modelo DS vem com mais um conjunto de sensores para sinal de porta e da fechadura

Instalação

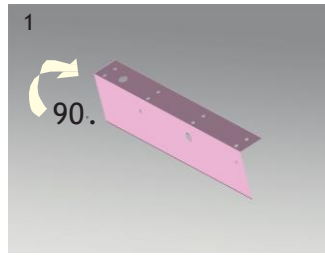
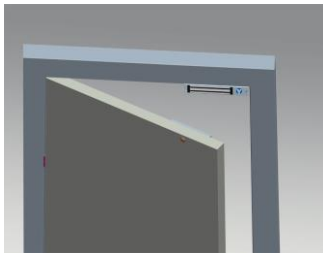

1 Dobrar a folha com as marcações;

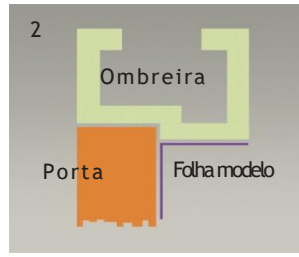

2 Fechar a porta e colocar a folha modelo com as marcações na posição pretendida;

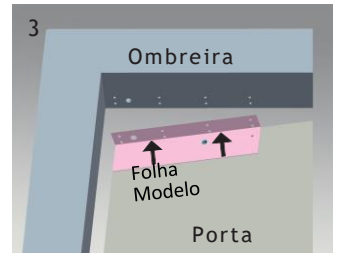

3 Marcar na porta e ombreira o sítio dos parafusos na placa de encaixe;

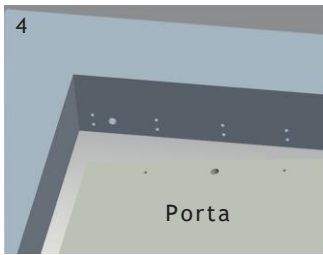

4 Fazer a furação das marcas;

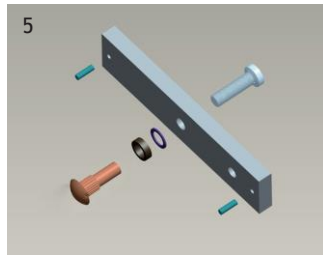

5 Encaixar as peças na placa;

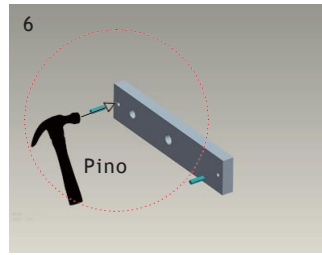

6 Com um martelo, encaixar o pino na placa, de modo a evitar movimentos ou trepidações;

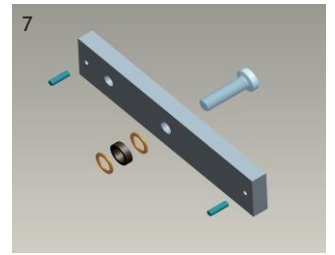

7 Montar os componentes como na imagem, não esquecendo das anilhas de borracha;

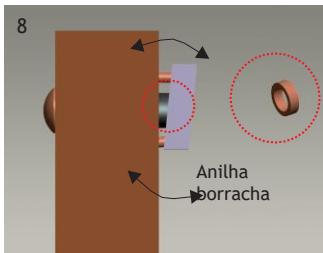

8 Colocar a anilha de borracha entre a placa e a porta;

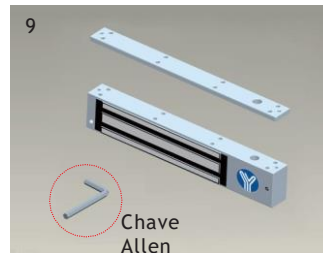

9 Usar a chave allen para separar a placa do corpo do electroíman;

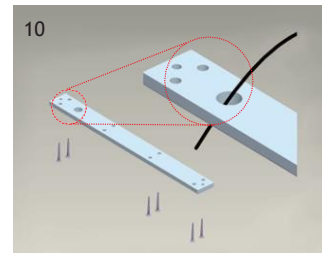

10 Fixar a placa na ombreira da porta de acordo com as furações;



11 Usar a chave allen para prender o electroíman à placa;

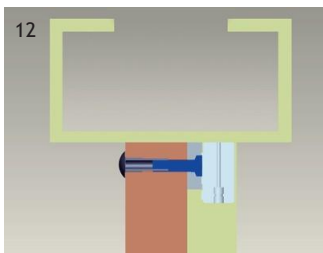

12 Fechar a porta para testar a força de retenção. A distância entre a placa e o electroíman pode ser ajustada com as anilhas;

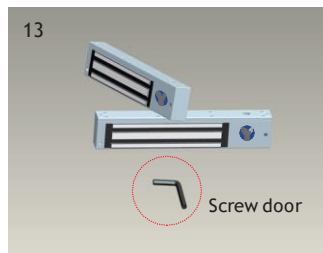

13 Fixar o parafuso anti-vandalismo;

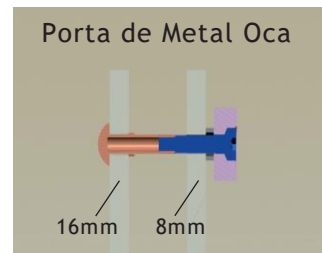

Porta de Metal Oca

Fazer um furo com as medidas
Interior Porta: 8 mm
Exterior Porta: 16 mm

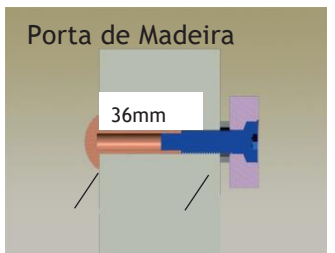

Porta de Madeira

Fazer um furo com as medidas
Interior Porta: 8 mm
Exterior Porta: 12,7 mm

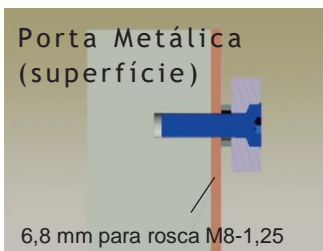

Porta Metálica (superfície)

6,8 mm para rosca M8-1,25

Interior Porta: fazer um furo com 8mm

⚠ Aviso:

Espessura da porta

350LBS: 44mm 600LBS: 50mm 800LBS: 48mm 1200LBS: 46mm

A. O parafuso da placa de armadura não deve estar muito apertado pois pode danificar a anilha de borracha. A anilha deverá ter elasticidade suficiente para garantir que a placa esteja ajustada à posição apropriada.

B. Verificar se a corrente necessária é de 12VDC ou 24VDC.

Temos disponíveis vários modelos de esquadros para a porta pretendida (madeira, metal, vidro) e o tipo de abertura (porta folha única ou dupla).

Esquadro "L"

Necessário para quando a espessura da porta é superior a 42mm.



Esquadro para porta simples

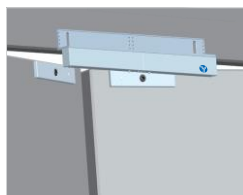

Esquadro para porta dupla

Esquadro de Protecção

Ideal para proteger e esconder fios eléctricos.
Peça única que sobrepõe o electroiman.



Esquadro para porta simples



Esquadro para porta dupla

Esquadro "ZL"

Necessário para portas com abertura para o interior.

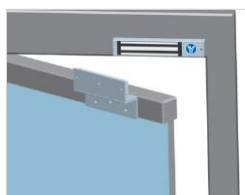

Esquadro para porta simples



Esquadro para porta dupla

Esquadro de Protecção - portas com aberturas para o interior.

Ideal para proteger e esconder fios eléctricos. Peça única que sobrepõe o electroiman.



Esquadro para porta simples

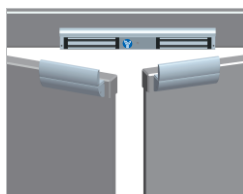

Esquadro para porta dupla

Esquadro "GZ"

Peça única, de material durável e aspecto profissional, de fácil instalação e adequado para portas de vidro sem moldura de 10-15 mm

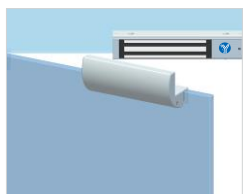

Esquadro para porta simples

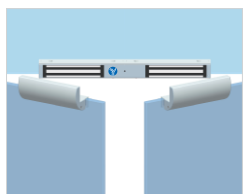

Esquadro para porta dupla

Luva de Fixação - Esquadro "U"

Para portas de vidro com 10 a 12mm de espessura

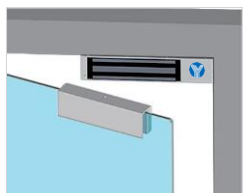

Esquadro de Extensão

Para portas com espessura superior, em conjunto com o esquadro "L"



Esquema para electroíman de porta dupla

Conexão: conexão verde ou branca, excepto para modelos sem saída para luz LED indicadora de estado; somente quando é detectado que as duas portas estão fechadas é que será transmitido um sinal.

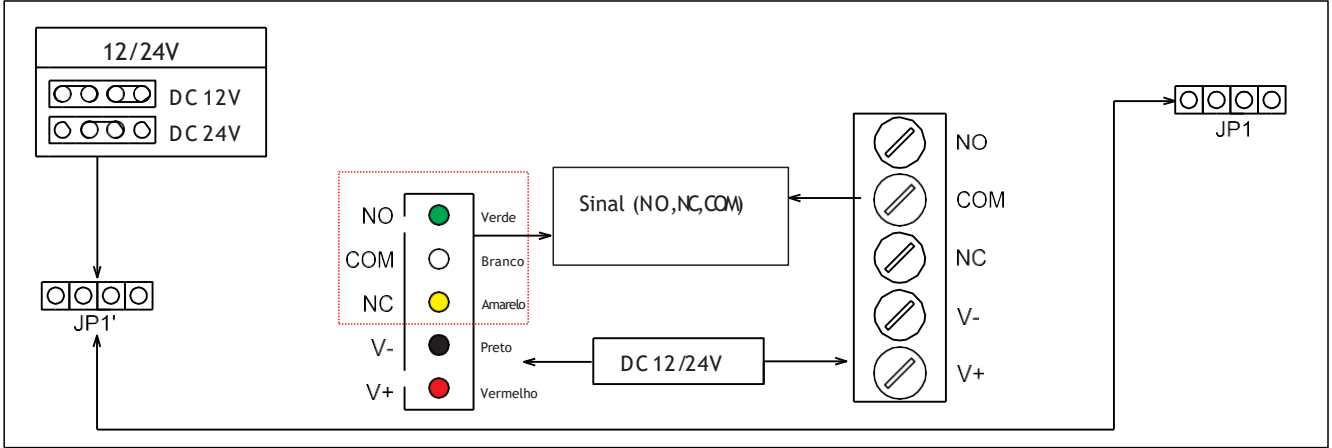

Diagrama de Conexão

