

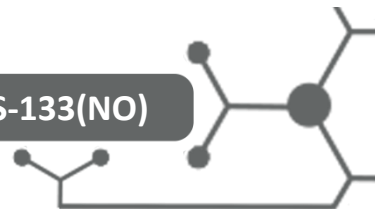

# Triplow

YS-133(NO)



## FICHA TÉCNICA YS-133(NO)



### Especificações

Alimentação (Tensão)	12V DC
Corrente	200 mA
Material	Aço Inoxidável
Força de retenção	500Kg
Tipo de Abertura	NO – Fail Safe
Temperatura	-10° ~ 55°
Humidade	0% a 90%
Espessura Vidro	12-15 mm
Peso	0.4Kg
Dimensões	160x25x31

### Dimensões

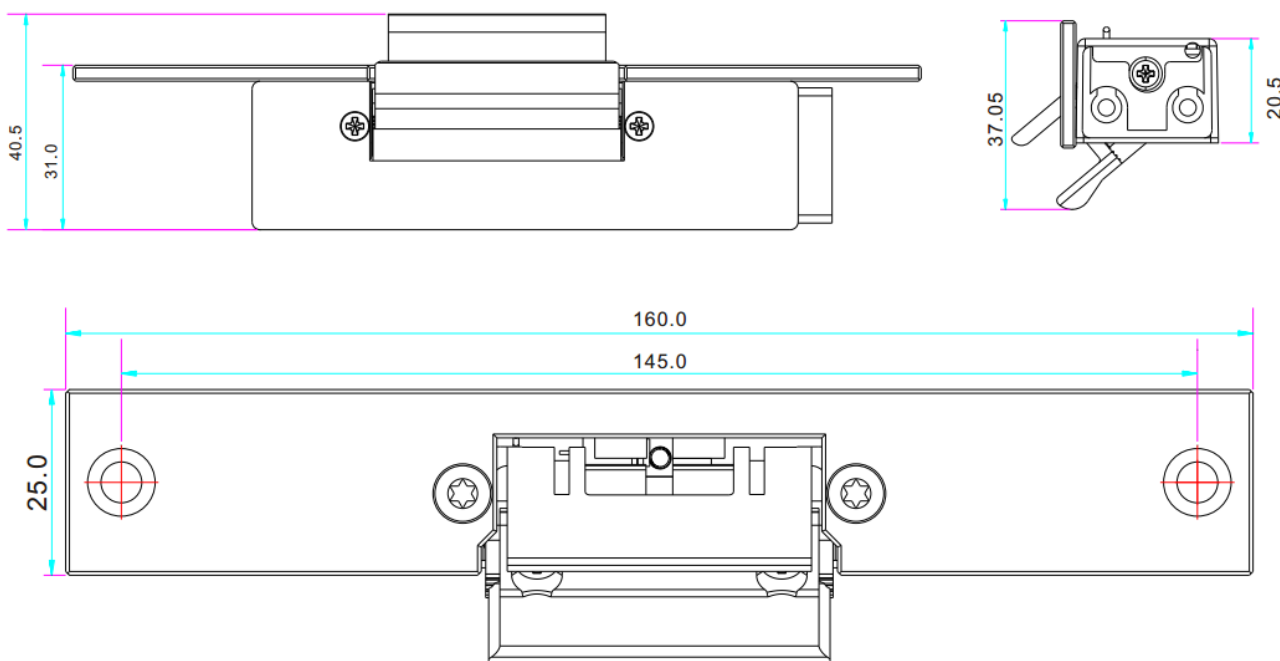



# Triplow

YS-133(NO)

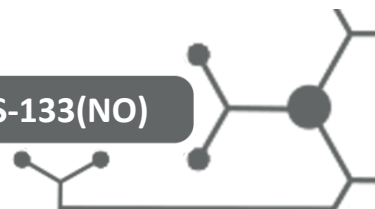

## Esquema de Furação

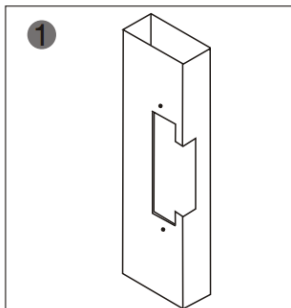

1  
Cortar buraco de acordo com a dimensão do trinco.

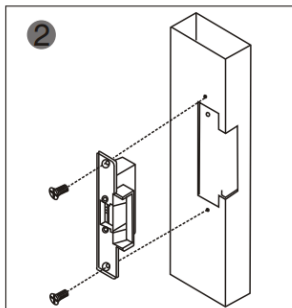

2  
Montar a fechadura e ligue a alimentação para testar.

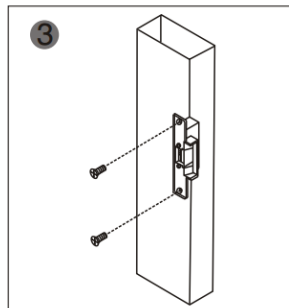

3  
Fixar o trinco eléctrico.

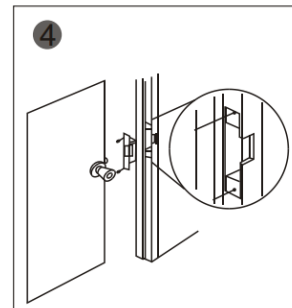

4  
Terminado.

