



YLI ELECTRONIC



Explosion-proof push button

Model: PBK-814E-EX

Specification

- Size: 75Lx80Wx63.05H(mm)
- Contact rating: 3A@36VDC
- Contact Output: NO
- Mechanical life: 100,000 tests
- Waterproof Level: IP66
- Material: Zinc alloy housing
- Certificate numbe:ECM 23 ATEX-B DN 89
- ATEX:II 1G Ex ib IIC T6 Gb
II 2D Ex ib IIIC T85°C /T100°C Db
- Operating temperature: -10 ~ +55°C(14-131F)
- Accessory: M16x1.5(4-8) explosion-proof cable connector
2 sets of crimp terminals + Nylon crimp cap
(Quick Disconnect Connectors)
- Weight: 0.4kg

Installation & Size

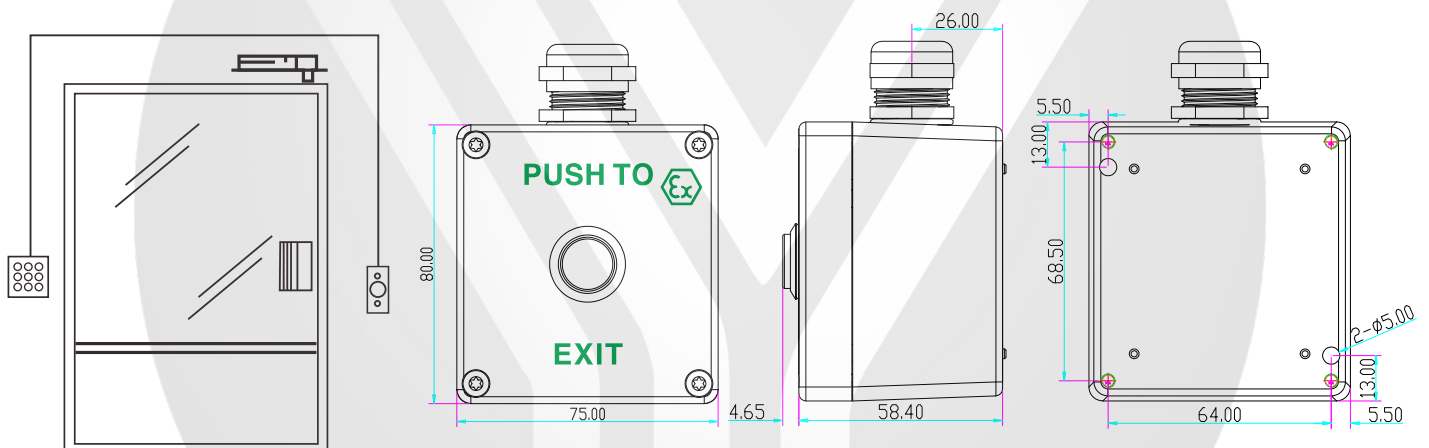

Wiring Diagram

