

# USER MANUAL – BLUETOOTH DIGITAL LOCK

## A210 Series

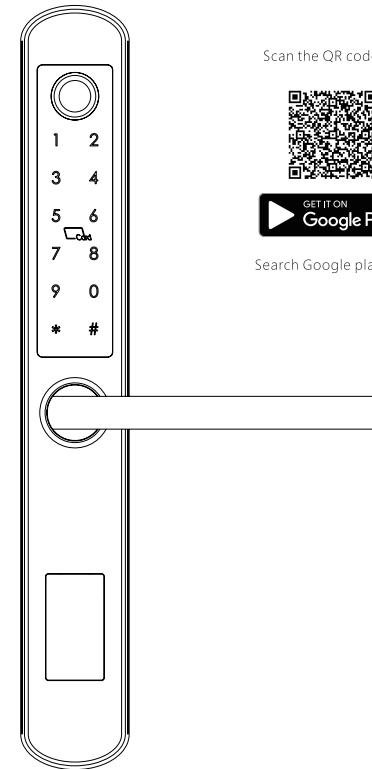

Scan the QR code below to download the APP



Search Google play or APPLE Store with TTLOCK



IC Card



Passcode



Key



APP



Fingerprint



Wristband

## 1 SYSTEM INTRODUCTION

Material	304# stainless steel,ABS,Acrylic
Available Color	Satin Nickel and Black Nickel
Door Thickness	38-55mm
Communication	Bluetooth 4.0 BLE
Support OS	iOS 7.0 or above, Android 4.4 or above
Battery Life	10000 times normal unlock(12 months)
Power Supply	Dc6v:4pcs AAA alkaline batteries
Static Current	45uA
Dynamic Current	<200mA
Unlock Way	IC card,passcode,fingerprint,APP,Wristband,mechanical key
Unlock Time	1-1.5 seconds
Working Temperature	-20~50 degree
Working Humidity	10%~95%
Factory Passcode	123456,after setting,factory passcode will be invalid
Available Mortise	35/85,45/85,50/85,60/85,70/85 European mortise
WiFi Gateway	Available(Optional)
Packing	Carton box with EPE inside

## 2 PRODUCT SPECIFICATION

### Front Panel

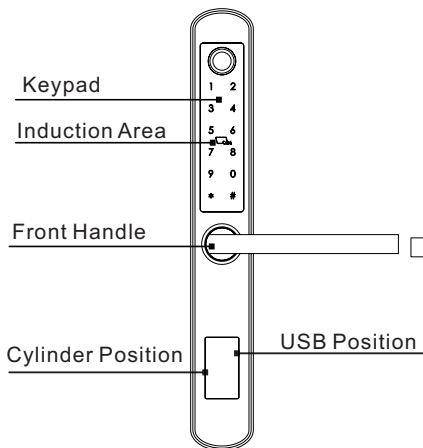

### Back Panel

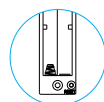
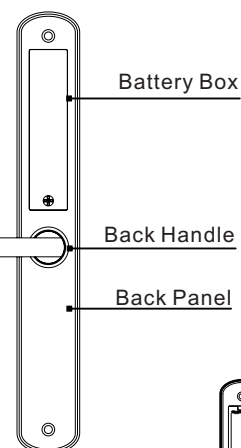

Reset Button

## 3 RESET TO FACTORY STATE

### Attention

Long press the button 2 seconds until 2 beeps to factory state, default passcode is: 123456. Under the factory state, the lock is on always open state, only when you power on the lock, the motor will be reset and handle will be in free state.

## 4 LOCK ACCESSORIES

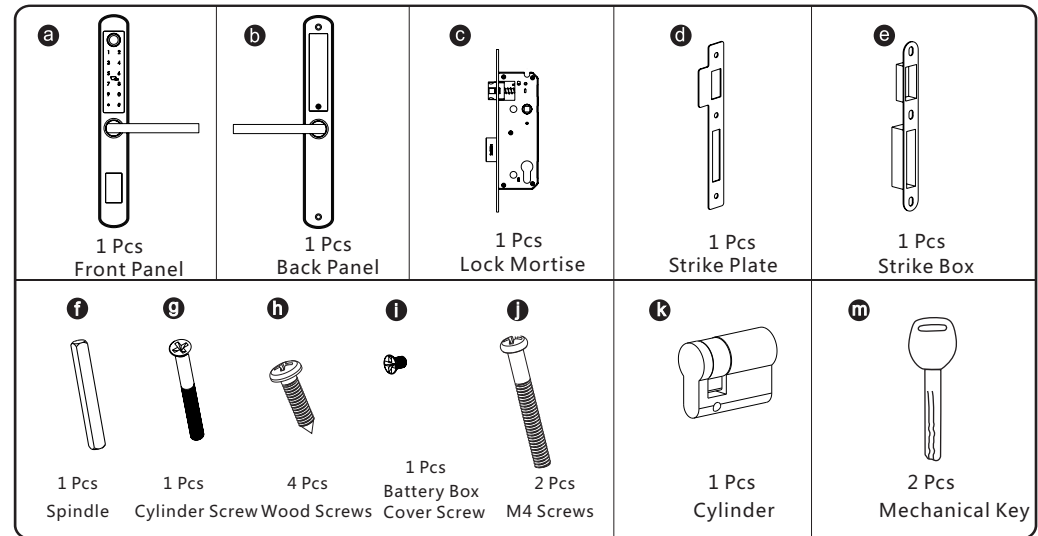

## 5 EXPLODED VIEW

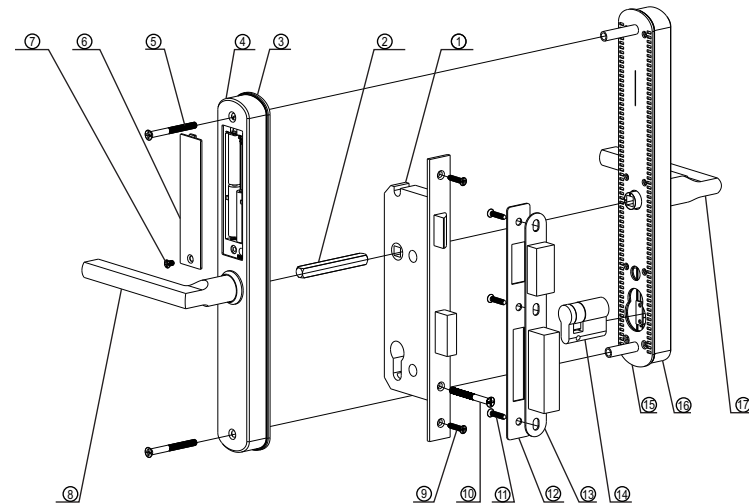

No.	Name	Quantity	No.	Name	Quantity
1	Mortise	1	10	Cylinder Screw	1
2	Spindle	1	11	Strike Screw	3
3	Rubber Gasket	1	12	Strike	1
4	Back Panel	1	13	Strike Box	1
5	Assemble Screw	2	14	Cylinder	1
6	Battery Box Cover	1	15	Front Gasket	1
7	Battery Cover	1	16	Front Panel	1
8	Back Handle	1	17	Front Handle	1
9	Faceplate Screw	2			

## 6 INFORMATION AND SAFETY WARNINGS:

### 6.1 Introduction

This user manual will guide you through the functions and usages of our A210 bluetooth smart lock. It is important that you follow the instructions and regard all notes that appear throughout this manual. Consult this manual before you attempt to use this lock. If you have any questions that not answered by this manual or on need of non-routine service, please call our customer service hotline or send FAQ to us.

### 6.2 Safety Warnings:

 When reading this manual, note these icons: notes with the icon **Must** be read, understood and obeyed to prevent injury or damage to the lock.

#### General Usage

- This lock shall only be used as described in this manual.
  - Verify that all parts of the lock are accounted for. If any parts are missing, please contact our service person.
  - Under factory default state, the lock is on always open status after you install the lock (no power on). It means the handle is free and lock can't be locked, you shall power on the lock with batteries or set admin and pair the lock with the APP and then the lock state will be changed to private mode automatically.
- 
- Handle directions are reversible, please kindly follow chapter 7 to change the direction if the door opening direction is not same with your lock. Should you have any problem, please contact our service person.
  - There is protective film on the front touch panel, if there are some scratches on the film, please remove the film if you need.
  - Please use 4pcs AAA batteries. Do not mix old and new batteries or other Zn/Mn batteries. Never insert objects into the lock other than batteries as described in this manual.
- 
- Verify all surfaces are flat and level before beginning installation, installation on doors or surface with any types of deformity such as gaps or warping may cause the lock to malfunction or fail to operate entirely.
  - Never apply any cleaner directly to any part of this lock. Only use clean water or mild cleaner on a soft non-abrasive cloth when cleaning.
- 
- Potential shock warning: do not allow water or liquids to get into the lock's electric parts.
  - The lock must be used with TTLOCK APP. The lock will function without the APP but full functionality may only be achieved when the APP is on use.

### 6.3 SALES AND SERVICE TERMS

- Please read the manual carefully before use!  
Limited 1-Year Electronic Warranty Limited Lifetime Mechanical and Finish Warranty
  - This A210 product comes with a 1-Year Limited Warranty on Electronic Parts and a Limited Lifetime Mechanical and Finish Warranty against defects in materials and workmanship under normal use to the original residential user. Proof of purchase and ownership is required for the warranty to be in effect.
- 
- Any change submit to our confirmation
  - Any error or question in our manual or sales term, please feel free to contact with us.
  - It is forbidden to copy our manual and for other usage, except the authorized company and users.
  - For any wrong operation or installation to the user or third party, we do not responsible for the duty.
  - For the damage caused by anthropic factor or inevitable reason, we do not pay for the loss or maintain for free, please check our after sale service terms.
  - Please do not take apart the lock if you are not technician, if necessary, please make the operations under the guide of technician.
  - Notice: there maybe a little difference for product pictures with real product, please subject to our real products. After changing the battery, please do not throw away the battery, kindly refund to recycle bin in case of pollution!

## 7 PREPARING TO INSTALL

### 7.1 Line Drawing

Draw a horizontal center line inside and outside the door at 1 meter from the ground. Fold the hole template, make the handle center line align at the door horizontal center line, then draw out the hole lines at front and side.

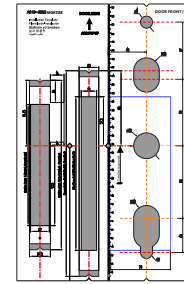

Template

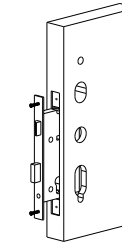

Trepanning



Screwdriver



### 7.2 Determining Lever Handing

The hand of the door is determined from the secure side of the door. The term "secure" means the side from which you initially unlock and enter from outside



**The hand of a door is determined from the secure side of the door.**  
**The term "secure" means the side from which you initially unlock and enter.**

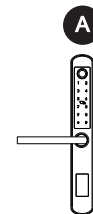
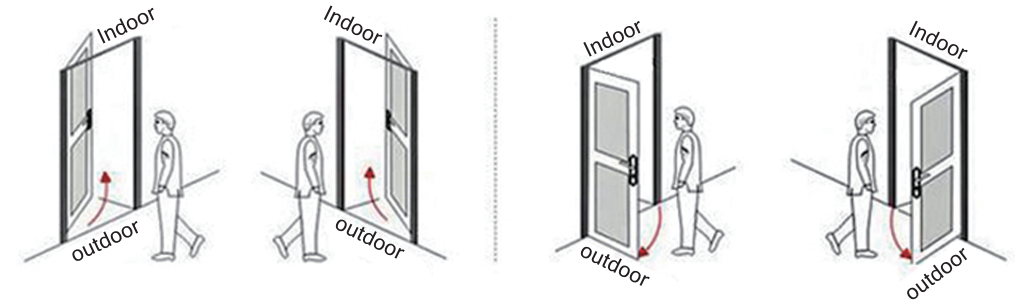

Left Push

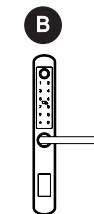

Right Push

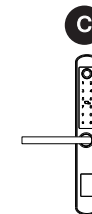

Left Pull

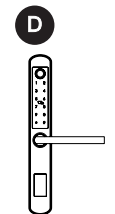

Right Pull

## 7.3 Change Handle

### 1. Adjust the Front Handle Direction

- 1.1 Use the allen key to take off the screw from the handle head.
- 1.2 Take off the handle.
- 1.3 Rotate the handle 180 degree and fix the direction that you need.
- 1.4 Tighten the screw with the allen key.
- 1.5 Adjust the clutch direction as the sign on the right.

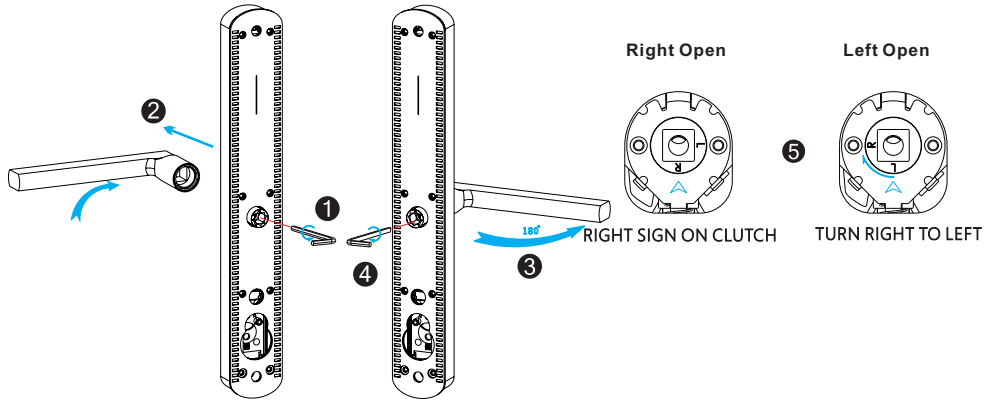

### 2. Adjust the Back Handle Direction

- 2.1 Use the allen key to take off the screw from the handle head.
- 2.2 Take off the handle.
- 2.3 Rotate the handle 180 degree and fix the direction that you need.
- 2.4 Tighten the screw with the allen key.
- 2.5 Adjust the handle if it is too tight.

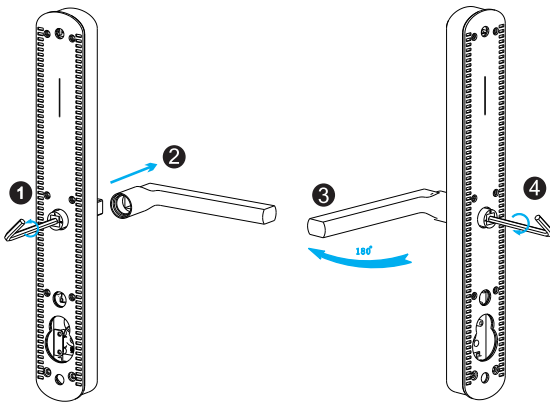

## 8 INSTALL THE LOCK

### 8.1 Assemble the Mortise

Assemble the mortise (c) into the slot which is drilled according to the template.

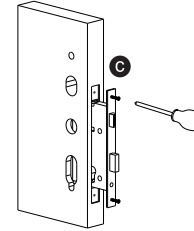

### 8.3 Assemble the Front Panel

Tight the front panel on the door (outside).

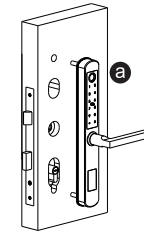

### 8.5 Assemble the Strike and Box

Put the strike box into the slot and fix the strike with the screws.

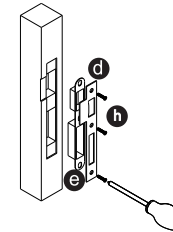

### 8.7 Test the Lock

Put 4 pcs AAA alkaline batteries into the battery box and test with factory passcode or APP.

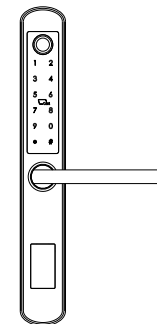

### 8.2 Assemble the Cylinder

Fix the cylinder (k) with the long screw through the hole on the faceplate.

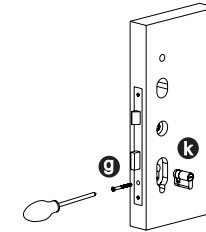

### 8.4 Assemble the back panel

Tight the back panel with front panel with the two long screws (f).

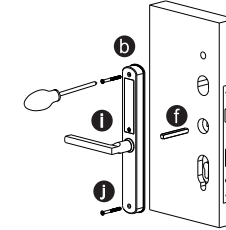

### 8.6 Test with the mechanical key

Test to unlock the door with the mechanical key and adjust the position if it is not smooth.

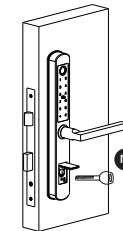

### 8.8 Adjust the Lock Panel

After test, please adjust the position of the lock panel or the screws if it is too tight.

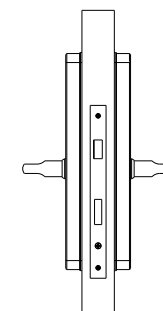

# Operations for Bluetooth Digital Lock

Search on APP store or Android store to download our APP and install it or scan the QR code we provided to install the APP program. You can also turn to us download the software. please read this manual carefully before installation and keep it properly.



Search Google play or APPLE Store with TTLOCK

## Attention

- Please turn on your phone's bluetooth function before any operation.

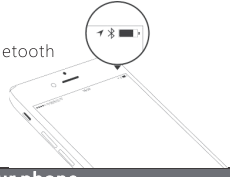

## 1.Add one smart lock on your phone

- When adding the door locks, operations must be completed near the lock.

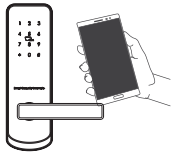

Step 1: Click "+" button Step 2: Select the lock Step 3: Click device name

- In step 3, there will be one + after the name of door locks, notice the door lock can not be added if there is no "+" sign. The interface will jump back to the key list after adding successfully. If the operation is failed, please repeat the above steps and view the device list in step3. Makes sure your mobile is turned on with bluetooth function and the door lock is powered with the battery already.
- if you are not the lock administrator, please contact the device administrator and ask for the secondary authorization for this lock.
- This feature requires the receivers to install the APP in their phone and register one account already.

## 2.Send one permanent eKey



Step 1: Click device name Step 2: Click the eKey Step 3: Enter the receiver info

## 3.Send one timed eKey

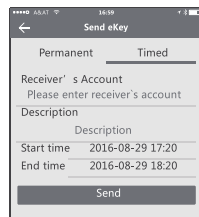

- During the authorized period of time, the receiver can unlock the lock without times limit, after the limitation of time, it will be invalidated automatically.

## 4.Send a timed passcode

- Passcode is with four types: Permanent, timed, cyclic and one-time. you can set the passcode accordingly.

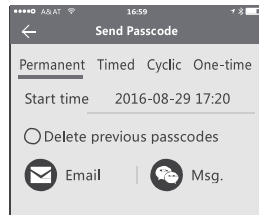

- Permanent passcode will not expire, but the administrator can delete them in the user list at any time.

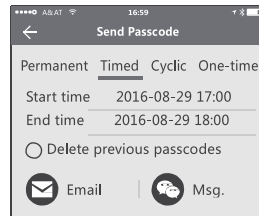

- Notice: if you tick the [Delete previous passcode], all the passcode that have been used on the lock will be deleted while the new generated passcode is used on the first time.
- The passcode shall be used once within 24 hours after the start time, otherwise it will be invalid.

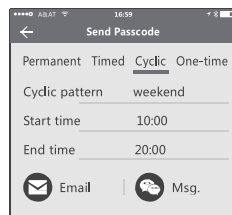

The cyclic passcode's cycle is one week and can be used cyclically for one defined period of time. For example, if the time is valid when setting to 10:00~20:00 every weekend, the user can only open the door at the setting time every weekend and can not open the door at any other time.

The passcode shall be used once within 24 hours after the start time, otherwise it will be invalid.

## 5.Send one-time eKey

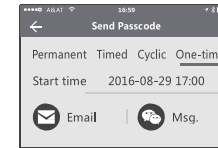

- The one-time passcode is valid for 6 hours after the start time, otherwise it will be invalid.

## 6.User management

- Passcode is with four types: Permanent, timed, cyclic and one-time. you can set the passcode accordingly.

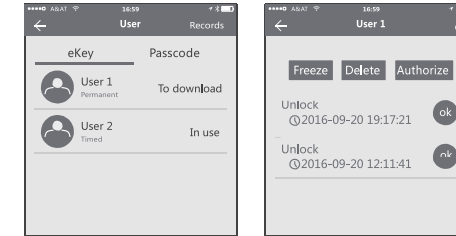

- In the list of eKey user management, click the user perform the according operation:

[Modify Validity]: click the ✎ to modify the validity period of user's previous eKey  
 [Freeze]: The user key can be temporarily frozen so that it is disabled the unlock function.

The function can be recovered after freezing is removed.  
 [Authorize]: Authorize the receiver to send an eKey or passcode to other users, In all of the above operations, the phones of two parties need to connect to the internet, if the users can not connect the network correctly, the administrator's command will be responded after the internet is connected.

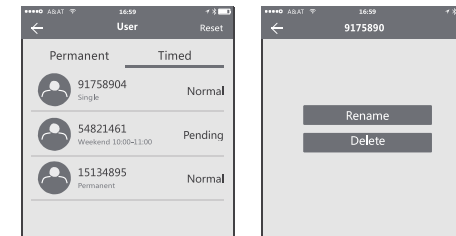

- In the list of passcode user management, you can label the user.

[Rename]: This function can label the user and facilitate the management of passcodes.  
 [Delete]: This function can delete the user directly.

## 7.Unlocking Records Query

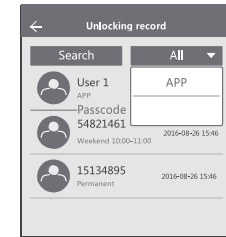

- Each time the ordinary user unlocks the lock with the key sent by the administrator, one record will be generated automatically and sent to the administrator's phone APP.

## Attention

- If one lock has been added by one phone, it can not be added by other new phone unless:
  - The previous administrator delete it from his APP next to the lock.
  - The reset button on the lock is long pressed for initialization.

- Deleting the passcode must be operated next to the lock.
- Enter the software interface and click the "≡" button to add locks as the pop-up list suggest.

## 8.Key Setting

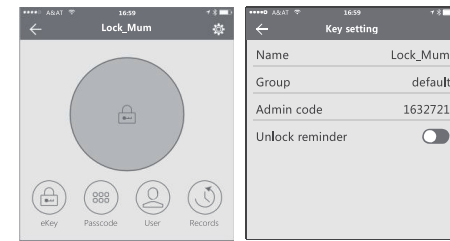

- Enter the device interface and click the "⚙️" button to name the device and view the current administrator's passcode.

## 9.Delete the lock

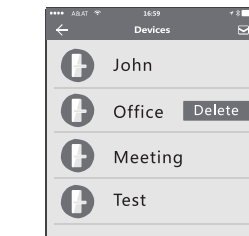

To delete the lock: slide the name to left and find the "Delete", you can delete the lock in the App. Also you shall long press the reset button on the rear side of front panel to set the lock to factory state. so the other user can add this lock as new device.

## 10. System Setting

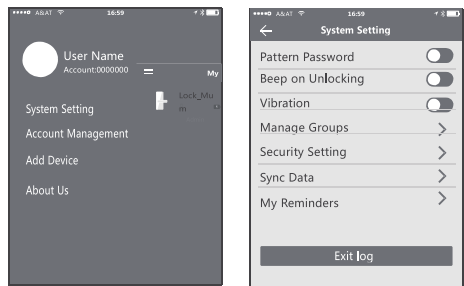

- Enter the software interface and click the "=" button, the options can be selected in the pop-up users.

## 11. Security Setting



- The verification function in the security setting is to prevent the illegal operation on a stolen or lost mobile phone. This function is only activated when the administrator operates the device and manages the users.

## 12. Account Management

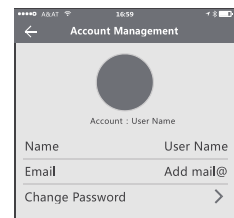

- Click the option to pop up the picture the uploading feature and set the image, display your account, mailbox and other information. To modify the password, verification of original password which is needed.

## WiFi Gateway(G1 Version)

- The WiFi gateway function in the APP is to allow the user to remote change the passcode, this is to enable the user to modify/delete the passcode when they are not close to the door lock. Under the system setting, you can find the gateway option:

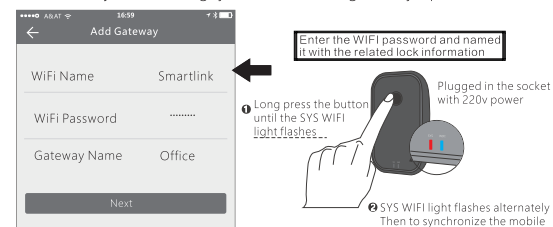

After the step is finished, the WiFi router will be linked with the door locks. Then you can remote change the passcode or valid time for the door locks.

## WiFi Gateway(G2 version)

- The new version WiFi gateway is with improved performance and long communication distance. Please refer to the parameters and operations.

Model:	G2
Dimension:	70x70x26mm
Network	WiFi 2.4G
IEEE Standard:	802.11b/g/n
Power Interface:	Type-C USB
Power Input:	DC5v/500mA

### Light Status

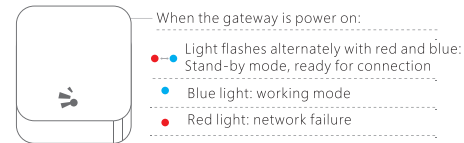

### Pair the Gateway with APP

- Activate the APP on mobile
- Press the button "≡"

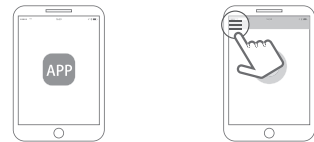

- Select the [Gateway]
- Select the [G2]



- Plug the gateway and power on it, while the light flashes alternately with red and blue

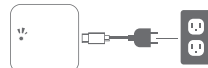

- Press the "+" sign



- Add Gateway
- Select the WiFi and enter the password



- Finish pairing Gateway

- Notice: if times out, please power on the gateway and try it again.